

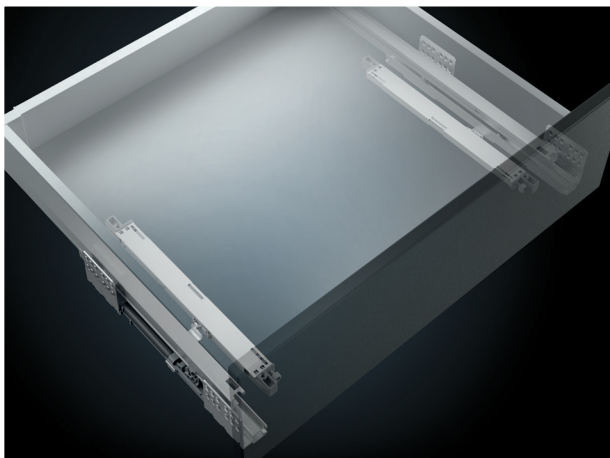

1.5mm
OPERATING
GAP

NEW Slimline SDWD-T

TOUCH OPENING



Push to Open Drawer Solution



The NEW Slimline SDWD-T is the latest push-to-open engineering innovation from Titus. The narrow operating gap ensures perfect drawer alignment and operation down to a minimum of 1.5mm with Titus proprietary damping technology.

Universal Mechanism

Designed to improve efficiency as well as drawer performance, the SDWD-T drawer uses a pre-mounted applicator and non-handed mechanism to shorten assembly time and make installation a breeze.

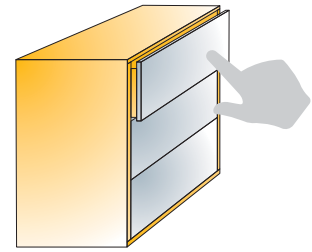
Tekform Slimline SDWD-T Drawers Touch Opening System

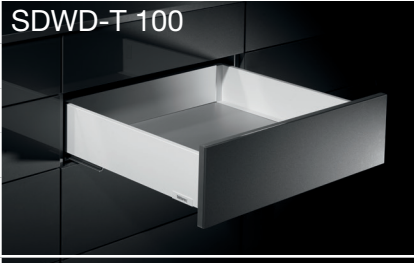

For use with SDWD-T Mechanisms	Height	Nominal Length (NL)	Minimum height required per drawer	Item number	White
 <p>SDWD-T 70</p>	70mm	400mm	115mm	655.8T61 →	150.00.K
	70mm	450mm	115mm	655.8T62 →	150.00.K
	70mm	500mm	115mm	655.8T63 →	150.00.K
	70mm	550mm	115mm	655.8T64 →	150.00.K
One set consists of: 2 pcs drawer sides, 2 pcs drawer runners, 2pcs EasyFix front connectors, 2pcs rear connectors, 2pcs covers, mounting instructions					
 <p>SDWD-T 100</p>	100mm	400mm	147mm	655.8U61 →	150.00.K
	100mm	450mm	147mm	655.8U62 →	150.00.K
	100mm	500mm	147mm	655.8U63 →	150.00.K
	100mm	550mm	147mm	655.8U64 →	150.00.K
One set consists of: 2 pcs drawer sides, 2 pcs drawer runners, 2pcs EasyFix front connectors, 2pcs rear connectors, 2pcs covers, mounting instructions					
 <p>SDWD-T 145</p>	145mm	400mm	198mm	655.8V61 →	150.00.K
	145mm	450mm	198mm	655.8V62 →	150.00.K
	145mm	500mm	198mm	655.8V63 →	150.00.K
	145mm	550mm	198mm	655.8V64 →	150.00.K
One set consists of: 2 pcs drawer sides, 2 pcs drawer runners, 2pcs EasyFix front connectors, 2pcs rear connectors, 2pcs covers, mounting instructions					
 <p>SDWD-T 182</p>	182mm	400mm	230mm	655.8Z61 →	150.00.K
	182mm	450mm	230mm	655.8Z62 →	150.00.K
	182mm	500mm	230mm	655.8Z63 →	150.00.K
	182mm	550mm	230mm	655.8Z64 →	150.00.K
One set consists of: 2 pcs drawer sides, 2 pcs drawer runners, 2pcs EasyFix front connectors, 2pcs rear connectors, 2pcs covers, mounting instructions					

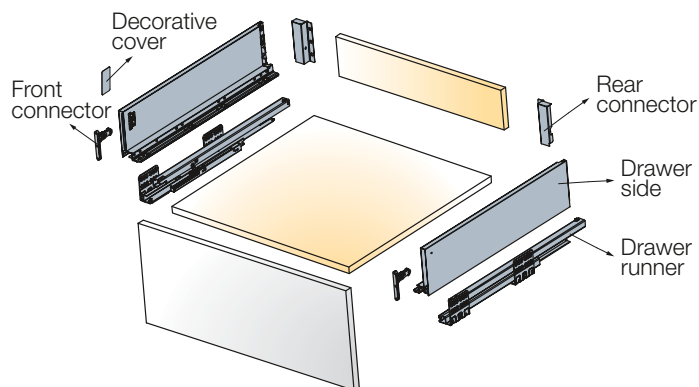

- Drawer runner type
 - Load capacity
 - Front connectors
 - Wooden back panel thickness
 - Wooden bottom panel thickness
- Full extension
40kg
EasyFix
16mm
16mm

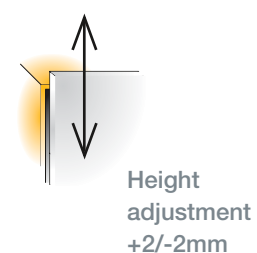
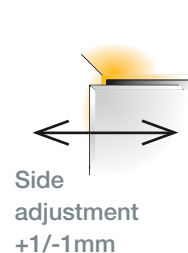

Tekform Slimline SDWD-T Mechanism Touch Opening System

- Fast and intuitive mounting without pre-drilling
- Reliable and secure closing
- Non-handed design
- Narrow 1.5mm operating gap for evenly aligned fronts

For use with SDWD-T Drawers

Item number

Zinc plated

SDWD-T Mechanism

655.9152.380 →

K1

One set consists of: 2 pcs PushOpen mechanisms (for one drawer application), 4pcs chipboard screws, mounting instructions

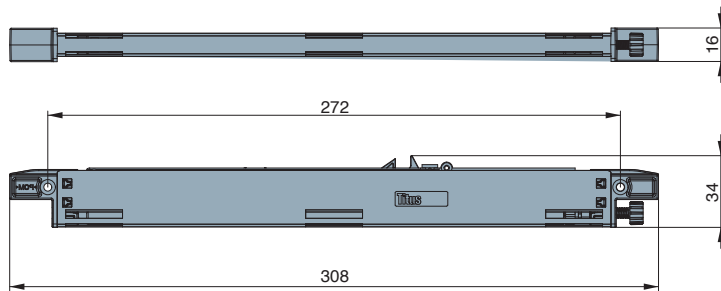

Depth adjustment

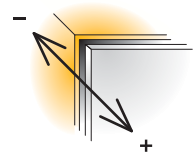
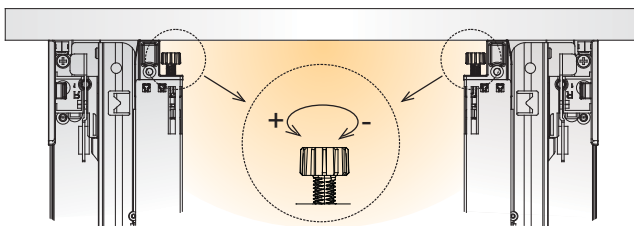

Depth adjustment
-0.5/+2.5mm

Tekform Slimline SDWD-T Touch Opening System

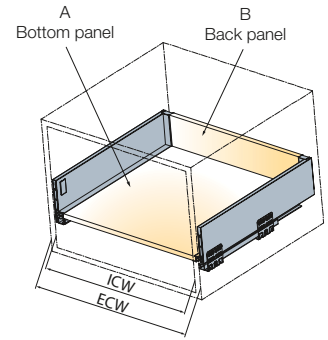

Cutting dimensions

ECW: External cabinet width
ICW: Internal cabinet width
NL: Nominal length of drawer
L_{st}: Length in case of steel back panel

SDWD-T 70

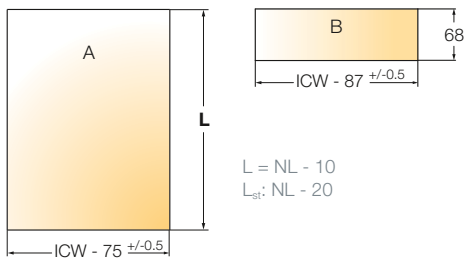

SDWD-T 100

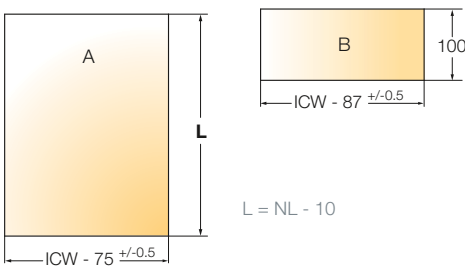

SDWD-T 145

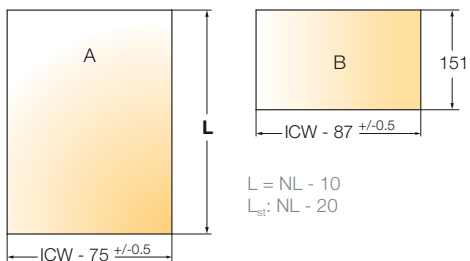

SDWD-T 182

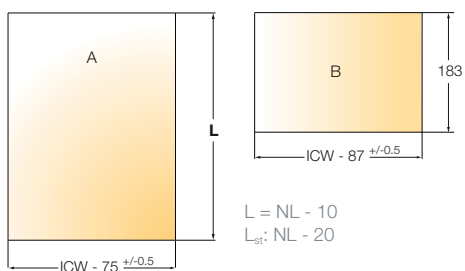

Drawer runner fixing positions

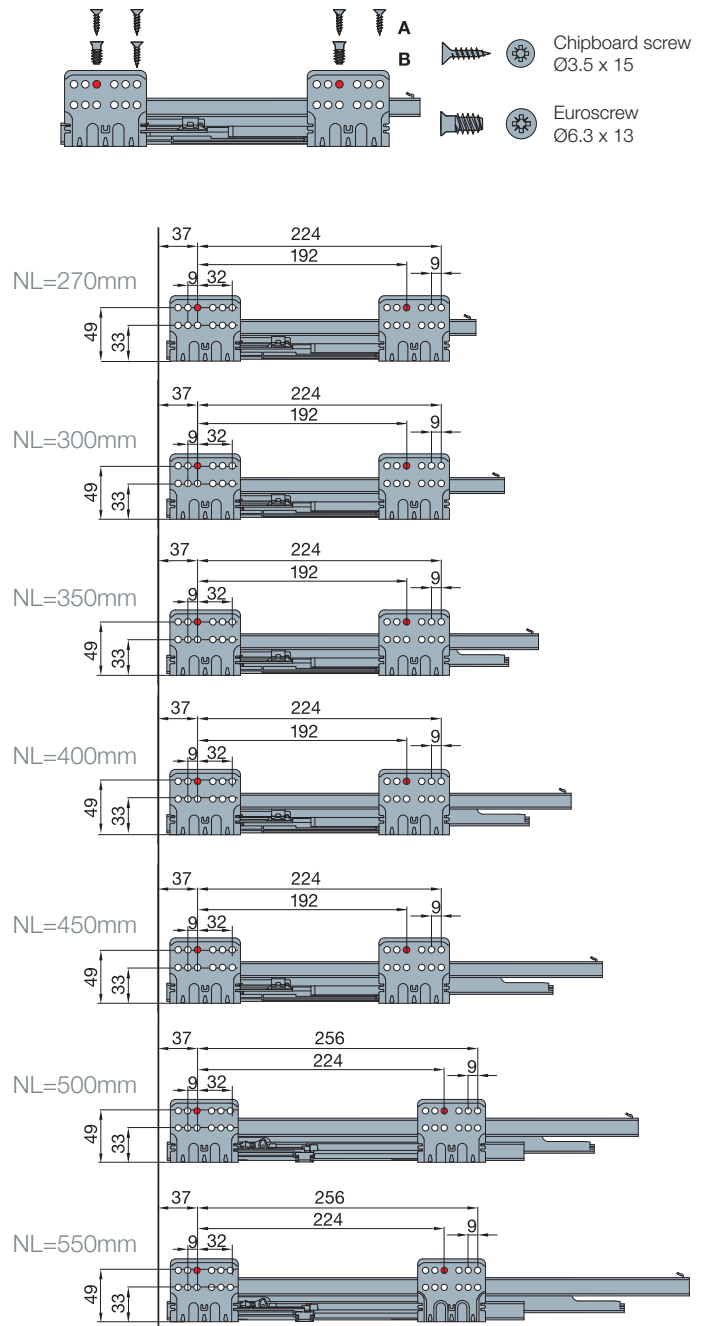

Installation dimensions SDWD-T 70

Minimum space required for the cabinet

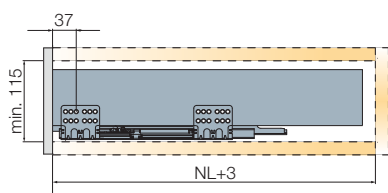

Drilling dimensions for the front panel

EasyFix attachment

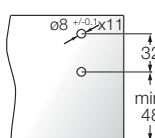

Screw-in attachment

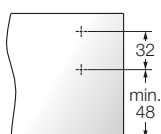

Mounting dimensions for the back panel

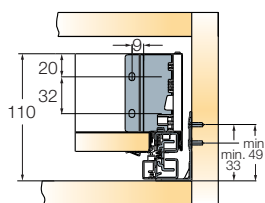

Installation dimensions for the front panel

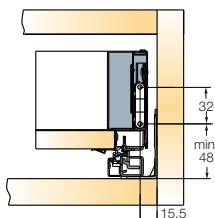

Installation dimensions SDWD-T 100

Minimum space required for the cabinet

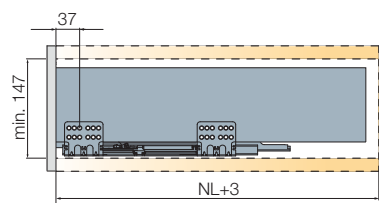

Drilling dimensions for the front panel

EasyFix attachment

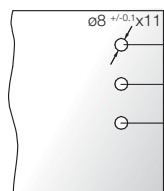

Screw-in attachment

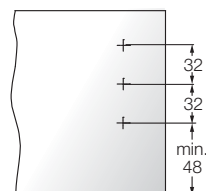

Mounting dimensions for the back panel

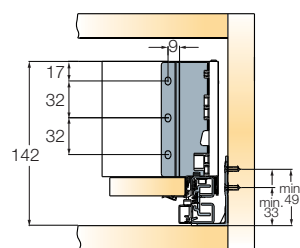

Installation dimensions for the front panel

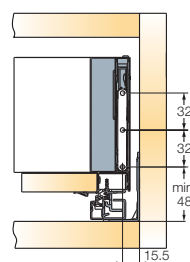

Tekform Slimline SDWD-T Touch Opening System

Installation dimensions SDWD-T 145

Minimum space required for the cabinet

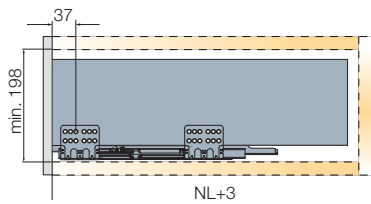

Drilling dimensions for the front panel

EasyFix attachment

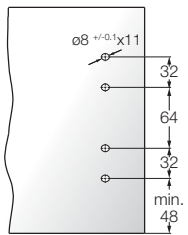

Screw-in attachment

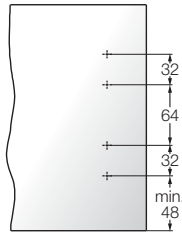

Mounting dimensions for the back panel

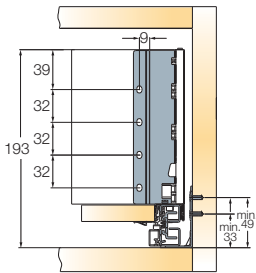

Installation dimensions for the front panel

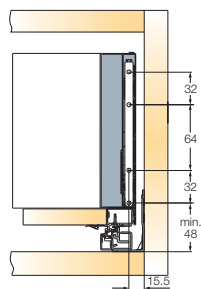

Installation dimensions SDWD-T 182

Minimum space required for the cabinet

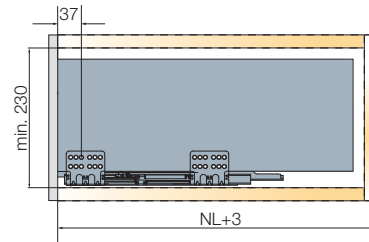

Drilling dimensions for the front panel

EasyFix attachment

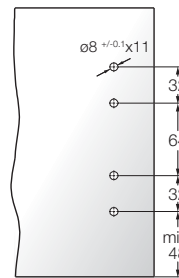

Screw-in attachment

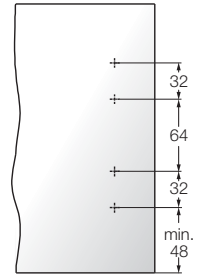

Mounting dimensions for the back panel

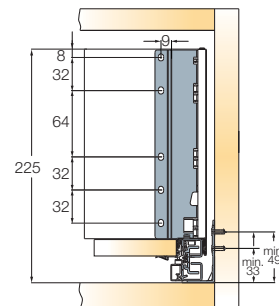

Installation dimensions for the front panel

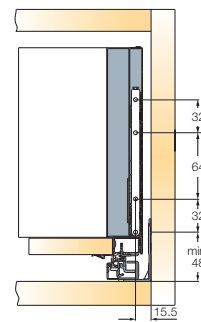

Mounting details

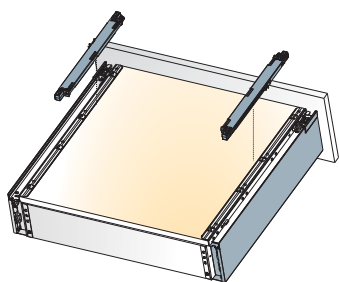

Position both SDWD-T mechanisms on the bottom of drawer

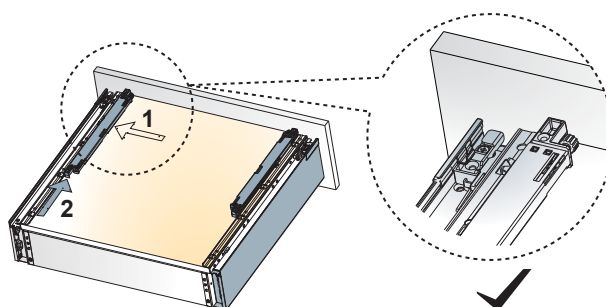

Align SDWD-T mechanisms with drawer lip and push to the front panel

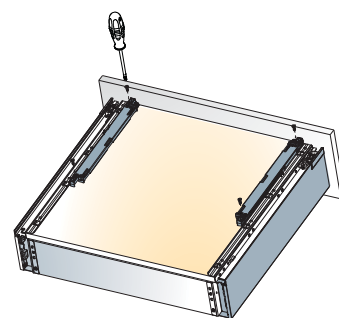

Screw-on both mechanisms

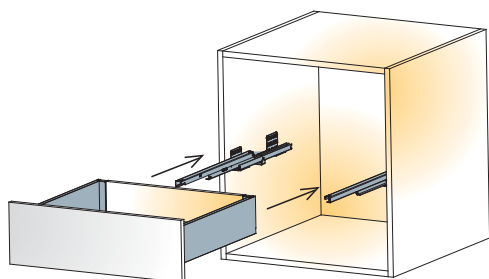

Place the drawer horizontally on the runners and push towards the cabinet until you hear the drawer is locked

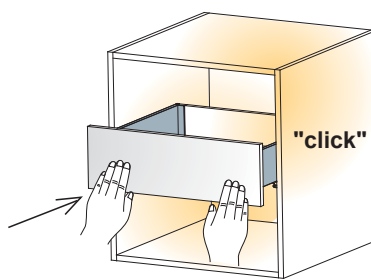

Push to fully close

Depth adjustment

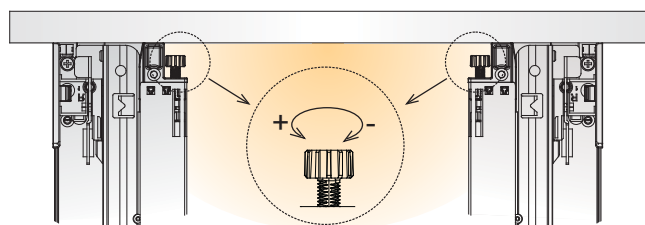

A trial mounting is always recommended.
For further information please contact your Technical Sales Representative.

Stefano Orlati

Titus+ Tekform

Titus Tekform Australia

www.titustekform.com.au

info@titustekform.com.au

1300-0-TITUS

Stefano Orlati New Zealand

www.stefano-orlati.com

stefano-orlati@titusplus.com

Connect with us



[LinkedIn.com/company/titustekform](https://www.linkedin.com/company/titustekform)



[Instagram.com/titustekform](https://www.instagram.com/titustekform)



[Pinterest.com/titustekform](https://www.pinterest.com/titustekform)



"Titus Tekform"