

# Titus Push Latch

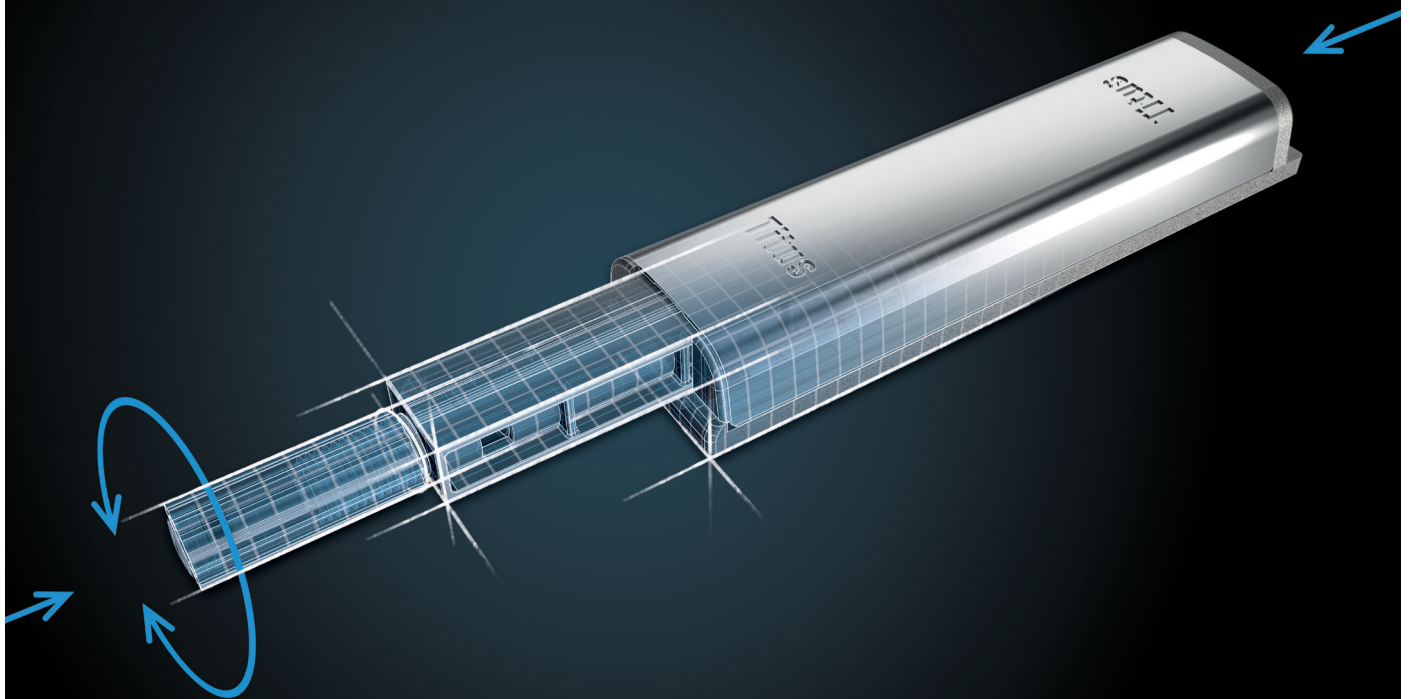

**Titus**

## Push Latch for Doors & Drawers Effortless Touch Opening

For the clean lines of European-style handleless drawers and doors, the Titus Push Latch enables a fluid push to open.

- Easy mounting with intuitive positioning
- Depth adjustment feature for tuned performance
- Retrofit existing cabinetry with ease
- Universal non-handed product for doors and drawers
- 'Safety click' feature for easy detachment of the mechanism from the plate

## Push Latch with Linear Mounting Plate

For wooden doors and drawers

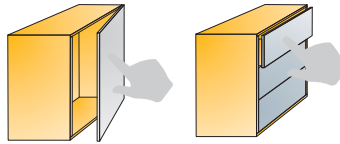

Item number

915.0X59.381.K2

Positioning:

Drilling pattern:

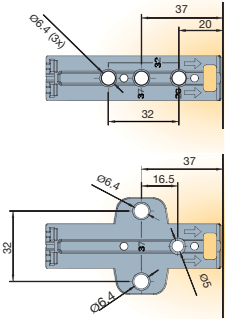

Depth Adjustment:

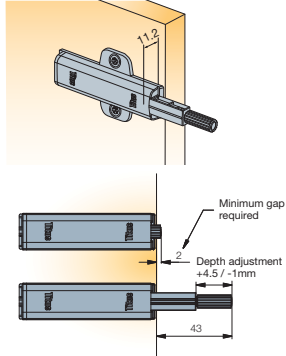

Close to the 'touch opening point' on the side opposite the hinges

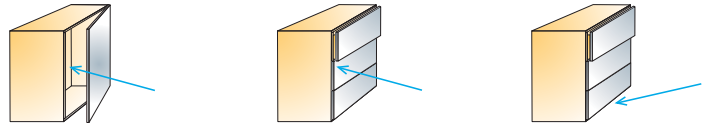

On the cabinet side; gap between drawer and cabinet side min. 12mm

In the middle of the bottom drawer

## Push Open - Short

For doors



Without housing

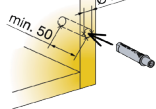

With housing

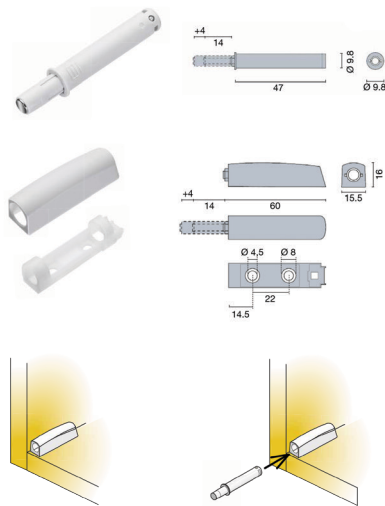
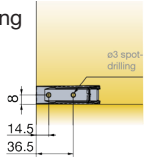

With bumper

Stroke	Finish	Item number
14	White	915.7187.350.00

With bumper

14	Grey	915.7187.383.00
----	------	-----------------

With magnet

14	White	915.7185.350.00
----	-------	-----------------

With magnet

14	Grey	915.7185.383.00
----	------	-----------------

Housing

	White	915.7192.350.00
--	-------	-----------------

Housing

	Grey	915.7192.383.00
--	------	-----------------

Bumper options for use with standard hinged doors.  
Magnet option for use with free-swinging or unsprung doors.

\*Depth Adjustment: +4/0mm by rotating adjustment screw

## Push Open - Long

For doors



Without housing

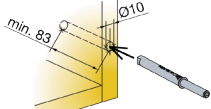

With housing

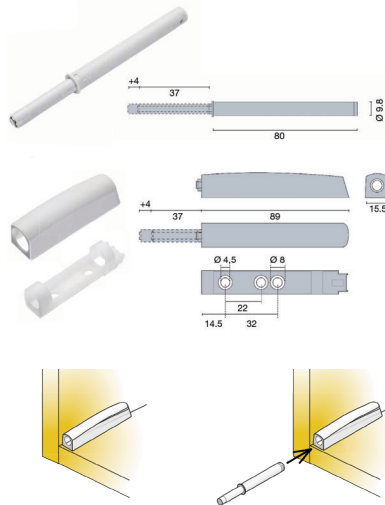
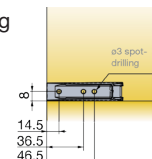

With bumper

Stroke	Finish	Item number
37	White	915.7188.350.00

With bumper

37	Grey	915.7188.383.00
----	------	-----------------

With magnet

37	White	915.7186.350.00
----	-------	-----------------

With magnet

37	Grey	915.7186.383.00
----	------	-----------------

Housing

	White	915.7193.350.00
--	-------	-----------------

Housing

	Grey	915.7193.383.00
--	------	-----------------

Bumper options for use with standard hinged doors.  
Magnet option for use with free-swinging or unsprung doors.

\*Depth Adjustment: +4/0mm by rotating adjustment screw

## Accessories

Counter plate Ø15: 915.7190.050.00

Self-adhesive counter plate Ø15: 915.7159.050.00

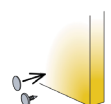
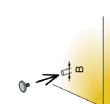
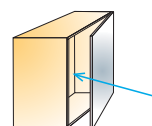

Pre-drilled hole: Ø8 x 10mm