

Innerware & Accessories

Innerware

Product guide

Kitchen Innerware

	Page
Corner Solutions	9.4
Base Solutions	9.9
Pantry Solutions	9.13
Wire Drawers	9.17
Wire Storage Baskets	9.18
Kitchen Accessories	9.19

Laundry Innerware

Tekno Laundry Hampers	9.20
Wire Basket Laundry Hampers	9.21

Wardrobe Innerware

Wardrobe Hanging Rail	9.22
GlideSoft RD Sliding Door Track	9.23
Titusoft SD100s	9.25
GlideSoft TP Sliding Door Track	9.27

Drawer Inserts

Kombi Cutlery Trays 9.30

Cutlery Inserts 9.34

Spice Trays 9.35

Utensil Organisers 9.36

Waste Bins

Tidy Bins 9.39

Single Pull-out Bins 9.40

Twin Pull-out Bins 9.41

Tekno Soft Close Bins 9.43

Tekno Soft Close Hampers 9.46

Kitchen Innerware Corner Solutions

- Door opening 450/500mm
- German engineered integrated soft close damping technology, tested to 50,000 cycles
- Non-slip water-resistant rubber mats with stylish European design for a quality finish
- Environmentally friendly durable chrome plated finish
- 10kg load capacity per tray



Swivel Corner Unit

	Suits outside cabinet width (mm)	Width (mm)	Depth (mm)	Height (mm)	Weight capacity (kg)	Item number
--	----------------------------------	------------	------------	-------------	----------------------	-------------

Left-hand	900	785	475	600-730	20	607.8D25.210.090
Right-hand	900	785	475	600-730	20	607.8D25.220.090

Left-hand

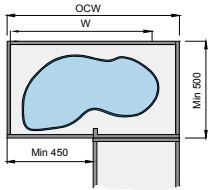

Right-hand

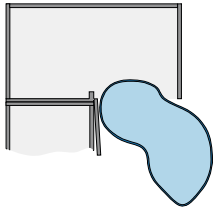
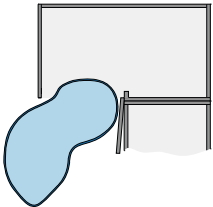
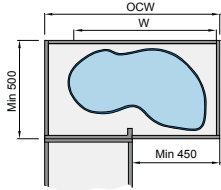

Kitchen Innerware Corner Solutions

- Door opening 450/500mm
- Soft close damping technology
- Complete access to corner storage
- Environmentally friendly durable chrome plated finish
- Max. 8kg per basket recommended



Full Access Corner Unit

Suits outside cabinet width (mm)	Width (mm)	Depth (mm)	Height (mm)	Weight capacity (kg)	Item number
----------------------------------	------------	------------	-------------	----------------------	-------------

800	615	525	595	20	607.8D25.595.045
-----	-----	-----	-----	----	------------------

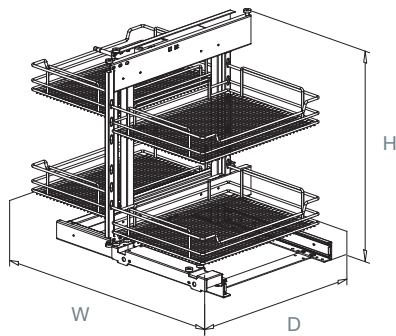

Kitchen Innerware Corner Solutions

- 270° rotation
- 12 polished chrome wire baskets
- Environmentally friendly durable chrome plated finish
- 4kg load capacity per basket
- Pie-cut and round cabinet applications



Easy Reach Corner Unit

Suits outside cabinet width (mm)	Width (mm)	Depth (mm)	Height (mm)	Weight capacity (kg)	Item number
900	785	785	650-750	48	607.8D25.760.090

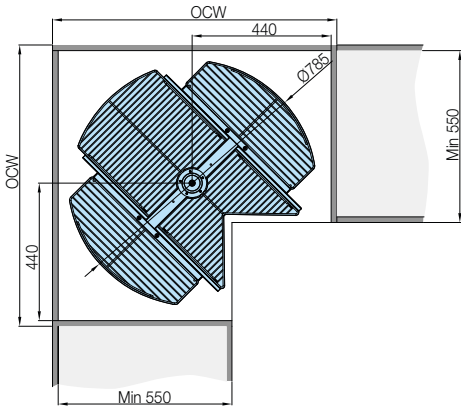

Kitchen Innerware Corner Solutions

- Door opening 450mm
- German engineered integrated soft close damping technology, tested to 50,000 cycles
- Superior interlock pantry design
- Environmentally friendly durable chrome plated finish
- 6kg load capacity per basket



Magic Corner Unit

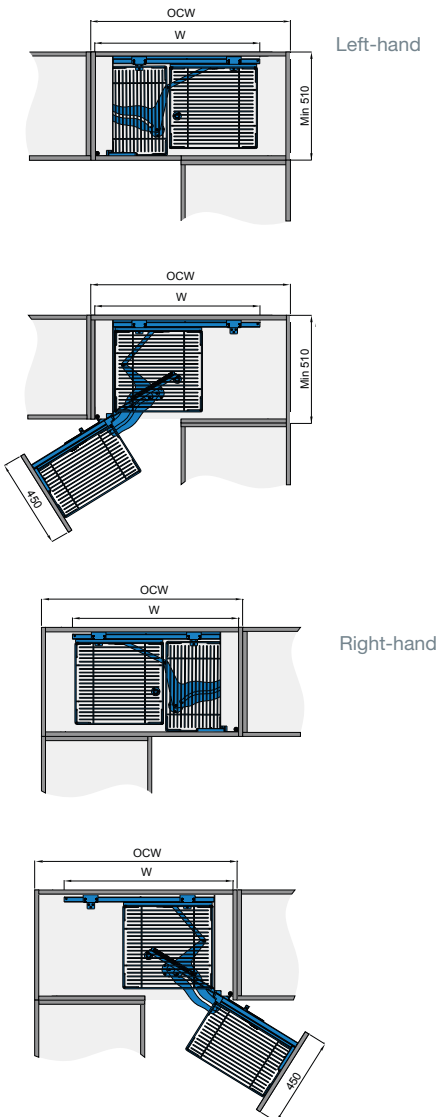

Opening direction	Suits outside cabinet width (mm)	Width (mm)	Depth (mm)	Height (mm)	Weight capacity (kg)	Item number
-------------------	----------------------------------	------------	------------	-------------	----------------------	-------------

Left-hand	900	860	510	620-750	25	607.8D26.520.045
Right-hand	900	860	510	620-750	25	607.8D27.520.045

Kitchen Innerware Corner Solutions

- 270° rotation
- Each carousel rotates independently for easy access and cleaning



270° Lazy Susan Corner Unit

Suits outside cabinet width (mm)	Diameter (mm)	Height (mm)	Weight capacity (kg)	Item number
800	710	565-790	20	607.8D25.070.090
900	820	720-1200	20	607.8D25.080.090

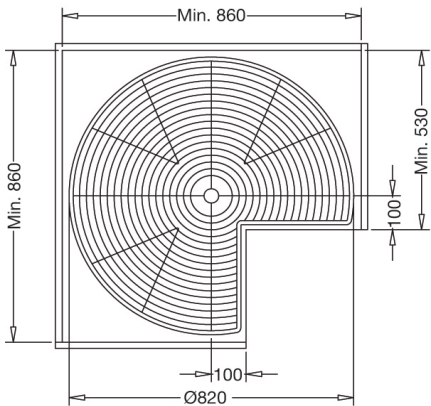

Kitchen Innerware Base Solutions

- German engineered integrated soft close damping technology, tested to 50,000 cycles
- Side mount installation
- Lux-look flat iron frame
- Non-slip water-resistant rubber mats with stylish European design for a quality finish
- Environmentally friendly durable chrome plated finish



Side Mount Pull-out Diamond Basket Utility Unit

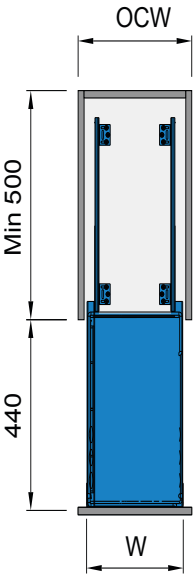

Opening direction	Suits cabinet width (mm)	Depth (mm)	Height (mm)	Weight capacity (kg)	Item number
Left-hand	200	460	580	25	607.8D92.465.020
Right-hand	200	460	580	25	607.8D92.465.020R
Left-hand	300	460	580	25	607.8D92.465.030
Right-hand	300	460	580	25	607.8D92.465.030R

Kitchen Innerware Base Solutions

- German engineered integrated soft close damping technology, tested to 50,000 cycles
- Side mount installation
- Environmentally friendly durable chrome plated finish
- 15kg load capacity per basket



Narrow Side Mount Pull-out Utility Unit

Suits outside cabinet width (mm)	Depth (mm)	Height (mm)	Weight capacity (kg)	Item number
150	455	505	30	607.8D80.500.015

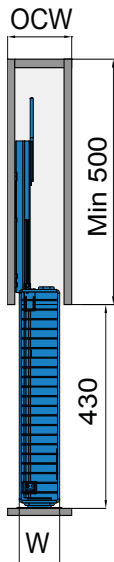

Kitchen Innerware Base Solutions

- German engineered integrated soft close damping technology, tested to 50,000 cycles
- Side mount installation
- Hinged or panel door
- Environmentally friendly durable chrome plated finish



Side Mount Pull-out Utility Unit

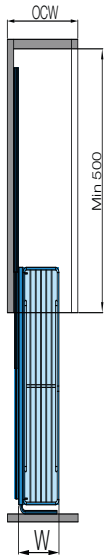

Opening direction	Suits cabinet width (mm)	Depth (mm)	Height (mm)	Weight capacity (kg)	Item number
Left-hand	200	479	566	25	607.8D90.596.020L
Right-hand	200	479	566	25	607.8D90.596.020R
Left-hand	300	479	566	25	607.8D90.596.030L
Right-hand	300	479	566	25	607.8D90.596.030R

Kitchen Innerware

Base Solutions

- German engineered integrated soft close damping technology, tested to 50,000 cycles
- Base mount installation
- Integrated injection wooden moulding
- Bottle rack and water tray included
- L-shaped base for stronger support and stable pull-out
- Environmentally friendly durable chrome plated finish



Base Mount Pull-out Utility Unit

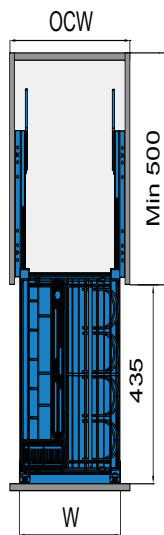

Suits cabinet width (mm)	Width (mm)	Depth (mm)	Height (mm)	Weight capacity (kg)	Item number
400	337	465	422	30	607.8D91.465.040
450	337	465	422	30	607.8D91.465.045

Kitchen Innerware Pantry Solutions

- German Red Dot Design Award winner
- German engineered integrated soft close damping technology, tested to 50,000 cycles
- 5 non-slip solid base trays with glass sides
- 20kg load capacity per tray recommended
- Superior interlock pantry design with exclusive lifting rail for simple tray height adjustment
- Environmentally friendly durable chrome plated finish



Space Pantry Unit



Suits outside cabinet width (mm)	Width (mm)	Depth (mm)	Height (mm)	Weight capacity (kg)	Item number
----------------------------------	------------	------------	-------------	----------------------	-------------

500	380	535	1720-2020	100	607.8D57.197.050
-----	-----	-----	-----------	-----	------------------

600	480	535	1720-2020	100	607.8D57.197.060
-----	-----	-----	-----------	-----	------------------

Kitchen Innerware Pantry Solutions

- Soft close damping technology
- 5 baskets – wire for 300mm/400mm, wire mesh for 450mm/500mm
- Max 10kg per basket recommended
- Environmentally friendly durable chrome plated finish



Pull-out Pantry Unit with Soft Close



300/400mm

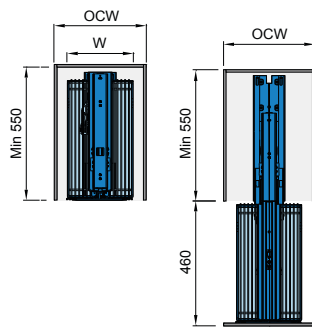

450/500mm

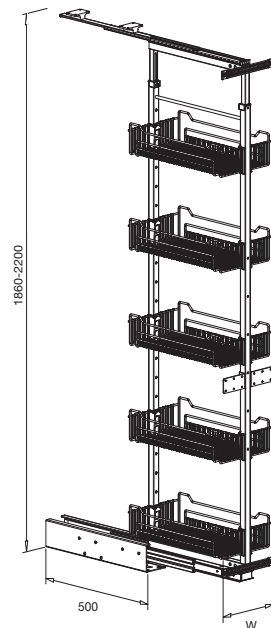

Suits outside cabinet width (mm)	Width (mm)	Depth (mm)	Height (mm)	Item number
300	250	500	1659-2059	607.8D55.222.030
400	350	500	1659-2059	607.8D55.222.040
450	395	500	1659-2059	607.8D55.222.045
500	445	500	1659-2059	607.8D55.222.050

- Min. internal carcass depth 535mm

Kitchen Innerware Pantry Solutions

- German engineered integrated soft close damping technology, tested to 50,000 cycles
- 6 layers of trays
- Swivel design allows all baskets to be moved to the front on opening
- 5kg load capacity per large basket and 3kg per small basket recommended
- Environmentally friendly durable chrome plated finish



Deluxe Pantry Unit

Suits outside cabinet width (mm)	Width (mm)	Depth (mm)	Height (mm)	Weight capacity (kg)	Item number
----------------------------------	------------	------------	-------------	----------------------	-------------

450/500	414	500	1820	48	607.8D56.197.045
---------	-----	-----	------	----	------------------

600	564	500	1820	48	607.8D56.197.060
-----	-----	-----	------	----	------------------

- Min. internal carcass depth 550mm

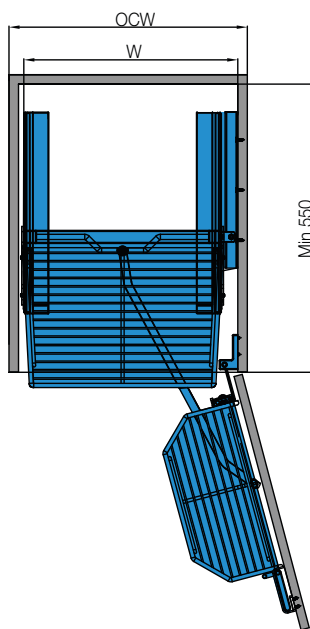

Kitchen Innerware Pantry Solutions

- Fits 400mm wide cabinets
- Steel with chrome baskets and grey frame

				Item number
<p>Compact Pull-out Pantry</p> 	400	935 - 1300	490	KA50106

Kitchen Innerware Wire Drawers

- Soft close damping technology
- Pull-out wire drawers for kitchen storage
- Weight capacity 40kg

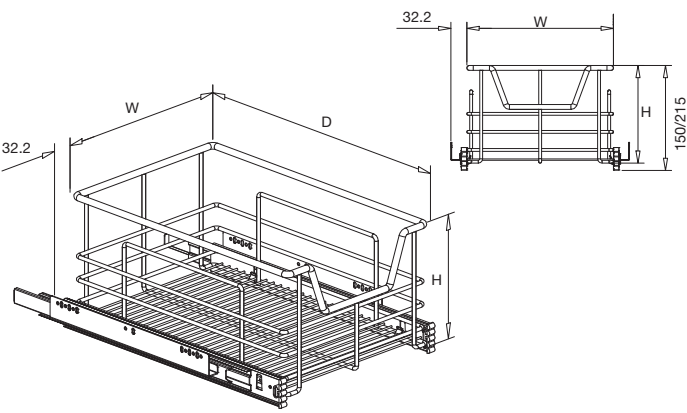
	Suits outside cabinet width (mm)	Width (mm)	Depth (mm)	Height (mm)	Item number
Wire Drawers with Soft Close	450	410-418	453	200	607.8D15.200.045
	500	460-468	453	200	607.8D15.200.050
	600	560-568	453	200	607.8D15.200.060
	800	760-768	453	200	607.8D15.200.080
	900	860-868	453	200	607.8D15.200.090
	400	360-368	453	135	607.8D15.135.040
	450	410-418	453	135	607.8D15.135.045
	500	460-468	453	135	607.8D15.135.050
	600	560-568	453	135	607.8D15.135.060
	800	760-768	453	135	607.8D15.135.080
	900	860-868	453	135	607.8D15.135.090
					

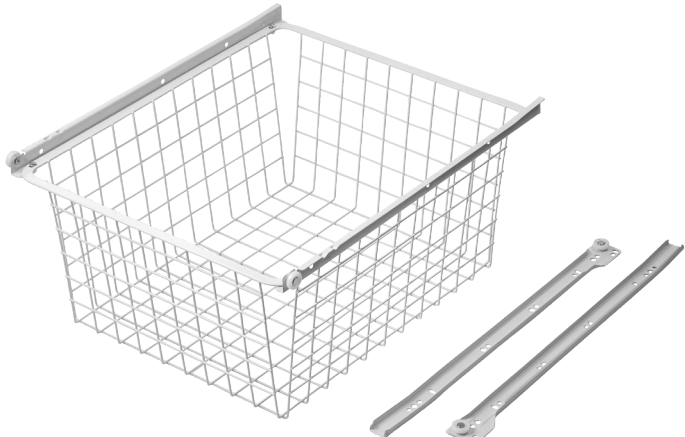

Kitchen Innerware

Wire Storage Baskets

	Internal cabinet width (mm)	Depth (mm)	Height (mm)	Item number
Wire Storage Basket with slides	466	400	200	607.8F02.168.002
	566	400	200	607.8F02.170.002
	393	450	140	607.8F02.174.002
	393	450	200	607.8F02.172.002
	416	450	140	607.8F02.178.002
	416	450	200	607.8F02.176.002
· White finish				

Kitchen Accessories

Kitchen Towel Rails

	Arms	Length (mm)	Finish	Item number
<p>Tea Towel Rail</p>  <p>Made of steel</p>	2	470	Chrome	607.8G03.890.200
<p>D-shape Tea Towel Rail</p>  <p>Made of steel</p>		300	Chrome	607.8G00.905.300
		380	Chrome	607.8G00.905.380

Laundry Innerware

Tekno Softclose Hampers

- Hampers suitable for use with Tekform Drawer
- For Tekno waste bins see page 9.43





Laundry Hamper







Depth (mm)	Width (mm)	Height (mm)	To suit cabinet width (mm)	Capacity	Mounting	Closing	Item Number
510	368	575	400	1x 35L	Door	Soft Close	607.8G07.435.271
510	418	550	450	1x 48L	Door	Soft Close	607.8G07.450.351
510	568	575	600	2x 35L	Door	Soft Close	607.8G07.470.241

Laundry Innerware Hampers

- Wire basket laundry hamper solutions
- For Tekno Laundry Hampers → see page 9.45

	Height (mm)	Width (mm)	Depth (mm)	Item number
<p>Tilting Laundry Hamper</p> 	495	406	377	607.8E60.406.007
	<ul style="list-style-type: none"> · Includes flap stay · Chrome finish 			
<p>Laundry Hamper for Drawers</p> 	600	370	460	607.8E60.307.001
	<ul style="list-style-type: none"> · Mounts to drawer front and base · White powder coated finish 			

Wardrobe Innerware

	Finish	Profile	Length (mm)	Height (mm)	Width (mm)	Item number
Wardrobe Hanging Rail 	Chrome	Round	3000	25	25	607.8E20.025.407
	Chrome	Round	3000	19	19	607.8E20.019.317
	Chrome	Oval	3000	30	15	607.8E21.030.307
End Flange 	Chrome	Round		55	25	607.8E20.025.307
	Chrome	Round		50	19	607.8E20.019.307
	Chrome	Oval		50		607.8E21.030.204
	· To use with wardrobe hanging rail					
End Pillar 	Chrome	Round		80	25	607.8E20.025.107
	Chrome	Round		70	19	607.8E20.019.107
	Chrome	Oval		75		607.8E21.030.109
	· To use with wardrobe hanging rail					
Centre Pillar 	Chrome	Round		80	25	607.8E20.025.207
	Chrome	Round		70	19	607.8E20.019.207
	Chrome	Oval		75		607.8E21.030.209
	· To use with wardrobe hanging rail					

Wardrobe Sliding Track



GlideSoft RD

- Floor to ceiling panel system
- Takes 10mm or 4mm panel, glass or acrylic
- Centre door soft close option
- Maximum width 3.6m
- Minimum width 600mm
- Installation depth 76mm
- Maximum installation height 2480mm
- 60kg weight capacity per door

	Finish	Length (mm)	Item number
<p>GlideSoft RD Handle Profile</p> 	Aluminium	2400	608.8V02.010.003
<p>GlideSoft RD Handle U Profile</p> 	Aluminium	2400	608.8V02.010.004
<p>GlideSoft RD Top Track</p> 	Aluminium	3600	608.8V02.010.001
<p>GlideSoft RD Bottom Track</p> 	Aluminium	3600	608.8V02.010.002

Wardrobe Sliding Track

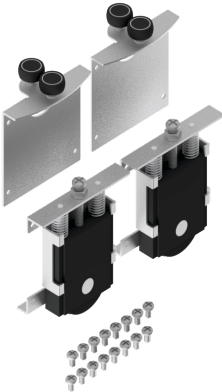
GlideSoft RD Fitting Kits

	Item number
<p>GlideSoft RD 1 Door Fitting Kit</p>  <p>The image shows the components of the GlideSoft RD 1 Door Fitting Kit. It includes two silver metal plates, two black roller mechanisms, and a set of screws. The roller mechanisms are shown in a perspective view, highlighting their internal rollers and mounting brackets.</p>	<p>608.8V02.010.006</p> <p>Kit includes:</p> <ul style="list-style-type: none">· 2x top mechanism· 2x bottom mechanism· Fixing screws
<p>GlideSoft RD Standard Close Stop Kit</p>  <p>The image shows the components of the GlideSoft RD Standard Close Stop Kit. It includes a silver metal bracket with a mounting hole, and two circular white support stops. The bracket is shown in a perspective view, highlighting its L-shaped design and the mounting hole.</p>	<p>608.8V02.010.010</p> <p>Kit includes:</p> <ul style="list-style-type: none">· Standard rest mechanism· 2x support stops

Wardrobe Sliding Track

Titusoft SD100s



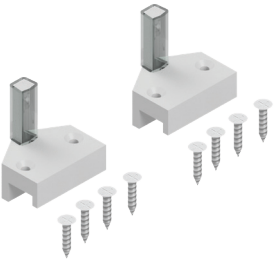

Soft Close Damping

- Compact design for bottom running tracks
- Effortless door opening
- Flexible mounting position
- 'ConfidentClose' with Titus damper

	Item number
<p>Titusoft SD100s Side Door Damping Kit</p> 	973.9060.380 Kit includes: <ul style="list-style-type: none">· 2x universal soft close dampers
<p>Actuator for SD100s</p> 	973.4451.010 Kit includes: <ul style="list-style-type: none">· 2x actuators· Fixing screws

Wardrobe Sliding Track

GlideSoft RD Products

	Length (mm)	Item number
<p>GlideSoft RD Brush Strip, 9.5mm</p> 	9.5	608.8V02.010.012
		<ul style="list-style-type: none"> · Brush strip for application to the back of the front door
<p>GlideSoft RD Brush Strip, 6mm</p> 	6	608.8V02.010.013
		<ul style="list-style-type: none"> · Brush strip for application to both sides of each door
<p>GlideSoft RD Gasket for 4mm Glass</p> 	3600	608.8V02.010.014
		<ul style="list-style-type: none"> · Applied to the back of the door as a wedge when using 4mm panels
<p>GlideSoft RD 20mm Coverstrip</p> 	2400	608.8V02.010.005
		<ul style="list-style-type: none"> · Thin aluminium strip used to cover the joint when using multiple panels for doors

Wardrobe Sliding Track

GlideSoft TP

- Cabinet based panel system
- For 16mm standard and 18mm routed panels
- Maximum width 3.6m
- Minimum width 600mm
- Installation depth 145mm
- Centre rest kit for centre doors
- 50kg weight capacity per door

	Finish	Length (mm)	Item number
<p>GlideSoft TP Handle Profile</p> 	Aluminium	2400	608.8V02.020.003
<p>GlideSoft TP Handle U Profile</p> 	Aluminium	2400	608.8V02.020.004
<p>GlideSoft TP Top Track</p> 	Aluminium	3600	608.8V02.020.001
<p>GlideSoft TP Bottom Track</p> 	ABS	3600	608.8V02.020.002

Wardrobe Sliding Track

GlideSoft TP Fitting Kits

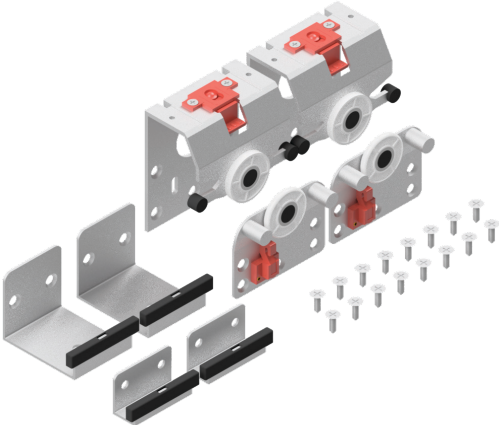
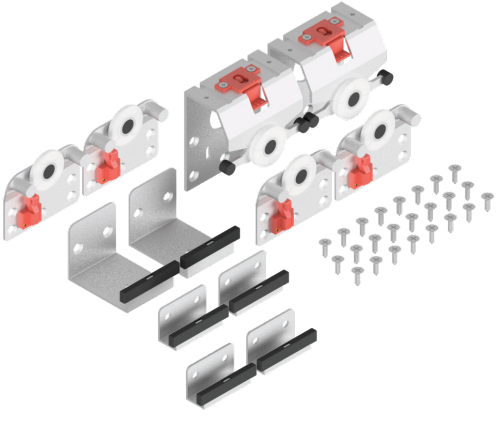

	Item number
<p data-bbox="152 805 472 856">GlideSoft TP 2 Door Fitting Kit</p> 	<p data-bbox="1084 805 1279 856">608.8V02.020.005</p> <p data-bbox="1084 856 1224 897">Kit includes:</p> <ul data-bbox="1084 897 1443 1035" style="list-style-type: none">· 1x Type 1 top mechanism set· 1x Type 2 top mechanism set· 1x Type 1 bottom rail runner set· 1x Type 2 bottom rail runner set· Fixing screws
<p data-bbox="152 1425 472 1476">GlideSoft TP 3 Door Fitting Kit</p> 	<p data-bbox="1084 1425 1279 1476">608.8V02.020.006</p> <p data-bbox="1084 1476 1224 1517">Kit includes:</p> <ul data-bbox="1084 1517 1443 1655" style="list-style-type: none">· 1x Type 1 top mechanism set· 2x Type 2 top mechanism set· 1x Type 1 bottom rail runner set· 2x Type 2 bottom rail runner set· Fixing screws

Wardrobe Sliding Track

GlideSoft TP

Closing Options

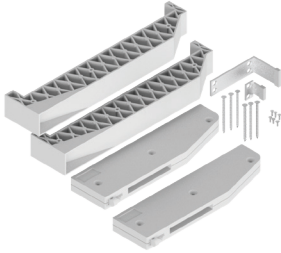
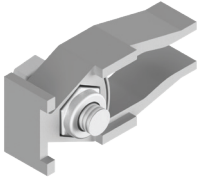
- Cabinet based panel system
- For 16mm standard and 18mm routed panels
- Maximum width 3.6m
- Minimum width 600mm
- Installation depth 145mm
- Centre rest kit for centre doors
- 50kg weight capacity per door



	Item number
<p>GlideSoft TP Left & Right Damping Kit</p> 	<p>608.8V02.020.007</p> <p>Kit includes:</p> <ul style="list-style-type: none"> · 2x soft close dampers · 1x large actuator · 1x small actuator · 2x support blocks · Fixing screws
<p>GlideSoft TP Standard Close Stop Kit</p> 	<p>608.8V02.020.008</p> <p>Kit includes:</p> <ul style="list-style-type: none"> · Standard rest mechanism
<p>GlideSoft TP Centre Rest Kit</p> 	<p>608.8V02.020.009</p> <p>Kit includes:</p> <ul style="list-style-type: none"> · Centre rest mechanism

Drawer Inserts

Drawer Inserts

Kombi Cutlery Trays

- Full usage of the drawer
- Suitable for all drawer types
- High quality plastic material
- Easy clean surface

	To suit drawer width (mm)	Depth (mm)	Width (mm)	Item number	Metallic	White
Kombi Cutlery Tray, 400mm 	400	441-500	301-350	607.8F22.040 →		201
	400	441-500	301-350	607.8F22.040 →	202	
Kombi Cutlery Tray, 450mm 	450	370-440	351-400	607.8F22.045 →	102	
	450	441-500	351-400	607.8F22.045 →		201
	450	441-500	351-400	607.8F22.045 →	202	
Kombi Cutlery Tray, 500mm 	500	441-500	401-450	607.8F22.050 →		201
	500	441-500	401-450	607.8F22.050 →	202	

Drawer Inserts

Kombi Cutlery Trays



- Full usage of the drawer
- Suitable for all drawer types
- High quality plastic material
- Easy clean surface

	To suit drawer width (mm)	Depth (mm)	Width (mm)	Item number	Metallic	White
Kombi Cutlery Tray, 550mm 	550	441-500	451-500	607.8F22.055 →		201
	550	441-500	451-500	607.8F22.055 →	202	
Kombi Cutlery Tray, 600mm 	600	370-440	501-550	607.8F22.060 →	102	
	600	441-500	501-550	607.8F22.060 →		201
	600	441-500	501-550	607.8F22.060 →	202	
Kombi Cutlery Tray, 650mm 	650	441-500	551-600	607.8F22.065 →		201
Kombi Cutlery Tray, 700mm 	700	370-440	601-650	607.8F22.070 →	102	
	700	441-500	601-650	607.8F22.070 →		201
	700	441-500	601-650	607.8F22.070 →	202	

Drawer Inserts

Kombi Cutlery Trays

- Full usage of the drawer
- Suitable for all drawer types
- High quality plastic material
- Easy clean surface

	To suit drawer width (mm)	Depth (mm)	Width (mm)	Item number	Metallic	White
Kombi Cutlery Tray, 800mm 	800	441-500	701-750	607.8F22.080 →		201
	800	441-500	701-750	607.8F22.080 →	202	
Kombi Cutlery Tray, 900mm 	900	441-500	801-850	607.8F22.090 →		201
	900	441-500	801-850	607.8F22.090 →	202	
Kombi Cutlery Tray, 1000mm 	1000	441-500	901-950	607.8F22.100 →		201
	1000	441-500	901-950	607.8F22.100 →	202	

Drawer Inserts

Cutlery Inserts





- High-impact Styrene
- Injection moulds
- Uniform thickness
- Trim for versatility to suit most drawers

	To suit drawer width (mm)	Depth (mm)	Width (mm)	Item number	Metallic	White
Cutlery Insert, 450mm 	450	346-435	306-450	607.8F03.101 →		001
	450	362-484	357-445	607.8F03.102 →		001
Cutlery Insert, 550mm 	550	373-483	482-532	607.8F03.107 →		001
Utensil Trays, 450mm 	450	441-500	351-400	607.8F23.045 →		201
	450	441-500	351-400	607.8F23.045 →	202	
Utensil Trays, 600mm 	600	441-500	501-550	607.8F23.600 →		201
	600	441-500	501-550	607.8F23.600 →	202	

Drawer Inserts

Spice Trays

- High-impact Styrene
- Injection moulds
- Uniform thickness
- Trim for versatility to suit most drawers

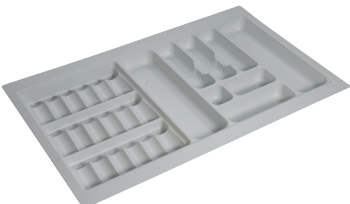
	To suit drawer width (mm)	Depth (mm)	Width (mm)	Item number	White	Grey
Spice Tray, 450mm 	450	430-520	350-390	607.8G23.045 →	001	
	450	430-520	350-390	607.8G23.045 →		002
Spice Tray, 500mm 	500	430-520	400-440	607.8G23.050 →		002
Spice Tray, 600mm 	600	430-520	500-540	607.8G23.060 →	001	
	600	430-520	500-540	607.8G23.060 →		002
Spice / Cutlery Tray, 800mm 	800	430-520	700-740	607.8G24.080 →	001	
	800	430-520	700-740	607.8G24.080 →		002
Spice / Cutlery Tray, 900mm 	900	430-520	800-840	607.8G24.090 →	001	
	900	430-520	800-840	607.8G24.090 →		002

Drawer Inserts

Utensil Organisers

- Durable and attractive stainless steel
- Designed to provide a space left or right of the tray for long utensils

	Depth (mm)	Width (mm)	Item number	Stainless steel
Triple Cutlery Organiser 	450	280	607.8E12.208 →	459
	500	280	607.8E12.208 →	509
	550	280	607.8E12.208 →	559
Cutlery Utensil Organiser, 208mm Range 	450	208	607.8E13.208 →	459
	500	208	607.8E13.208 →	509
	550	208	607.8E13.208 →	559
Cutlery Utensil Organiser, 309mm Range 	450	309	607.8E13.308 →	459
	500	309	607.8E13.308 →	509
	550	309	607.8E13.308 →	559
Cutlery Utensil Organiser, 377mm Range 	450	377	607.8E13.377 →	459
	500	377	607.8E13.377 →	509
	550	377	607.8E13.377 →	559

Drawer Inserts Utensil Organisers

- Durable and attractive stainless steel
- Designed to maximise your drawer space and versatility

	Depth (mm)	Width (mm)	Item number	Stainless steel
Double Utensil Organiser 	450	202	607.8E12.202 →	459
	500	202	607.8E12.202 →	509
	550	202	607.8E12.202 →	559
Double Utensil Organiser, Large 	450	291	607.8E12.291 →	459
	500	291	607.8E12.291 →	509
	550	291	607.8E12.291 →	559
Single Utensil Organiser 	450	105	607.8E12.105 →	459
	500	105	607.8E12.105 →	509
	550	105	607.8E12.105 →	559

Waste Bins

Waste Bins

Single Bins

- Removable hi-impact bin for easy cleaning
- Right or left opening



Tidy Bin 8L

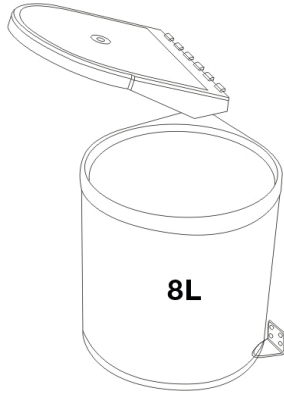

Depth (mm)	Width (mm)	Height (mm)	Capacity	Mounting	Item number	Stainless steel	White
300	300	280	8L	Door	607.8G03.008 →		201
300	300	280	8L	Door	607.8G03.008 →	209	

· Automatic opening lid

Tidy Bin 12L

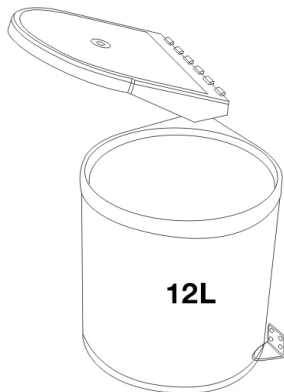

290	290	320	12L	Door	607.8G03.012 →		201
-----	-----	-----	-----	------	----------------	--	-----

· Automatic opening lid

Waste Bins

Single Bins

- Soft close damping technology
- Closed lid position minimises odours
- Removable hi-impact bin for easy cleaning

	Depth (mm)	Width (mm)	Height (mm)	Capacity	Mounting	Item number	White
Bottom Mounted Tidy Bin	360	262	310	15L	Bottom	607.8G03.115 →	101
 <ul style="list-style-type: none"> • Ideal for apartment/townhouse environment • Small bin to suit vanity • Perfect for under sink applications • Simple DIY installation to the base of the cabinet • Soft close ball bearing runners 							

Waste Bins

Pull-out Twin Bins

- Closed lid position minimises odours
- Removable hi-impact plastic bins for easy cleaning



Twin Bin Pull-out with Metal Frame, Bottom Mounted



Depth (mm)	Width (mm)	Height (mm)	Capacity	Mounting	Item number	Grey	White
510	262	420	30L	Bottom	607.8G03.030 →		001
510	262	420	30L	Bottom	607.8G03.030 →	007*	

- Right or left opening
- Sturdy, hi-impact frame
- 1x 20L bucket and 1x 10L bucket
- To suit 300mm cabinet

Twin Bin Pull-out with Metal Frame, Door Mounted



490	262	420	30L	Door	607.8G06.130 →		231
-----	-----	-----	-----	------	----------------	--	-----

- Sturdy, hi-impact frame
- 1x 20L bucket and 1x 10L bucket
- To suit 300mm cabinet

Waste Bins

Pull-out Twin Bins

- Closed lid position minimises odours
- Removable hi-impact plastic bins for easy cleaning



Twin Bin Pull-out Double Bins with Metal Frame



Depth (mm)	Width (mm)	Height (mm)	Capacity	Mounting	Item number	White
510	340	320	2x 15L	Bottom	607.8G06.030 →	101
510	340	380	2x 18L	Bottom	607.8G06.036 →	001
490	340	320	2x 15L	Door	607.8G06.030 →	201
490	340	380	2x 18L	Door	607.8G06.036 →	201

- Ideal for low shelf applications or plumbing
- Sturdy, hi-impact frame
- To suit 400mm cabinet

Twin Bin XL Pull-out with Metal Frame



470	464	470	1x 28L 2x 17L	Door	607.8G06.156 →	251
470	564	470	2x 28L	Door	607.8G06.156 →	261

- Sturdy, hi-impact frame
- Door panel attaches directly to bin

Waste Bins

Tekno Softclose Bins

- To suit 400mm outside cabinet width
- Bins suitable for use with Tekform Drawer
- For Tekno Laundry Hampers, see page 9.20

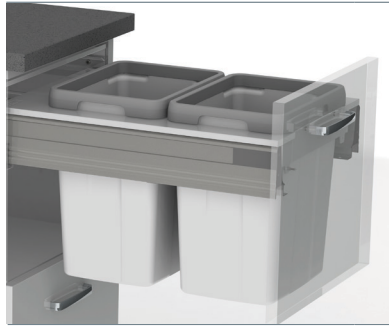

Tekno Bin with Soft Close 26L

Depth (mm)	Width (mm)	Height (mm)	Capacity	Mounting	Closing	Item number
506	368	340	26L	Door	Soft Close	607.8G06.304.040

- Includes 2x 13L buckets

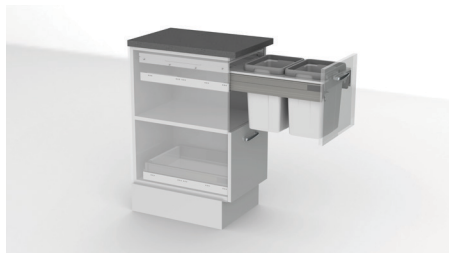

Tekno Twin Bin with Soft Close 36L

506	368	470	36L	Door	Soft Close	607.8G06.302.040
-----	-----	-----	-----	------	------------	------------------

- Includes 2x 18L buckets

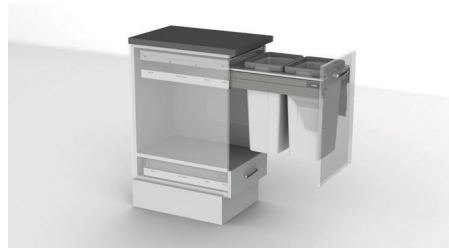

Tekno Bin with Soft Close 35L

506	368	570	35L	Door	Soft Close	607.8G06.300.040
-----	-----	-----	-----	------	------------	------------------

- Includes 1x 35L bucket



Waste Bins

Tekno Softclose Bins

- Bins suitable for use with Tekform Drawer
- For Tekno Laundry Hampers, see page 9.20

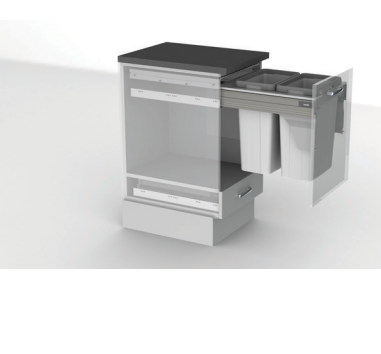
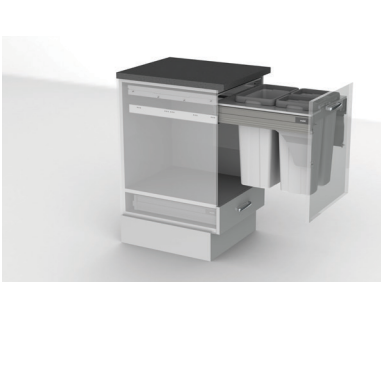
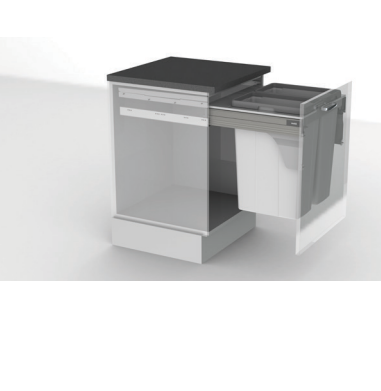
	Depth (mm)	Width (mm)	Height (mm)	Capacity	Mounting	Closing	Item number
Tekno Bin with Soft Close 42L	506	418	470	2x 21L	Door	Soft Close	607.8G04.442.171
	506	418	570	2x 27L	Door	Soft Close	607.8G04.454.151
• To suit 450mm cabinet width							
Tekno Twin Bin with Soft Close 39L	506	468	470	1x 21L 2x 9L	Door	Soft Close	607.8G04.439.151
	• To suit 500mm cabinet width						
Tekno Twin Bin with Soft Close 70L	506	562	506	2x 35L	Door	Soft Close	607.8G06.307.040
	• To suit 600mm cabinet width						

Waste Bins

Tekno Softclose Bins

- Bins suitable for use with Tekform Drawer
- For Tekno Laundry Hampers, see page 9.20



Tekno Side Mount Bin



	Depth (mm)	Width (mm)	Height (mm)	Capacity	Mounting	Closing	Item number
Tekno Side Mount Bin	510	312	350	26L	Side Mount	Soft Close	607.8G08.526.281
	510	312	480	36L	Side Mount	Soft Close	607.8G08.536.281
	<ul style="list-style-type: none"> · To suit 350mm cabinet width · Supplied complete with side mount soft close ball bearing drawer runners · Includes 2x 13L buckets (26L) or 2x 18L buckets (36L) 						
Spare Tekno Softclose 400mm Bin Frame	513	368				Soft Close	607.8G06.308.040
Spare Tekno Softclose 600mm Bin Frame	513	568				Soft Close	607.8G06.309.040
Spare Tekno Bin Bucket				18L			607.8G06.310.180
Spare Tekno Bin Bucket				13L			607.8G06.309.130
Spare Tekno Bin Bucket				35L			607.8G06.309.350
	<ul style="list-style-type: none"> · Replacement parts for Tekno Bins 						

Waste Bins

Kosara Softclose Waste Bin

- Undermount soft close runner system
- 2 removable high impact plastic bins
- Door mounted
- Fitted metal lid with non-slip mat
- Modern anthracite finish

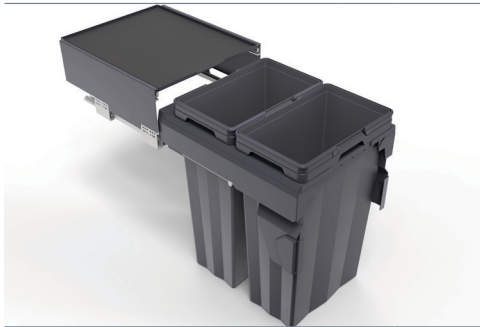

66L Kosara Anthracite Bin with Soft Close

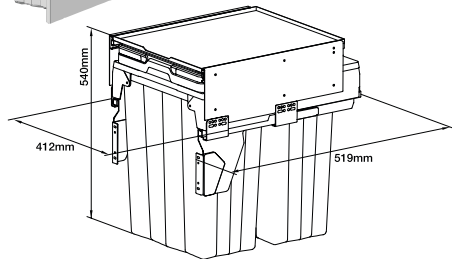
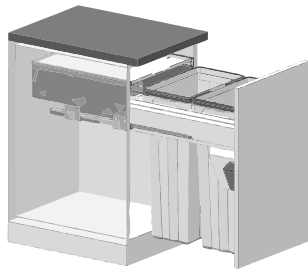

Made from plastic and steel

74L Kosara Anthracite Bin with Soft Close

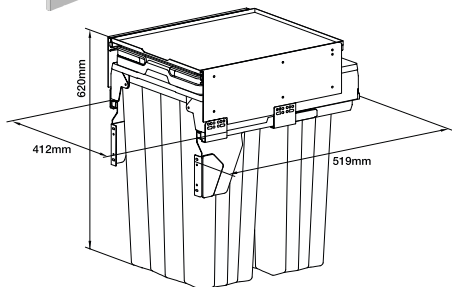
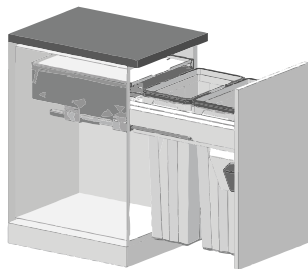

Made from plastic and steel

Depth (mm)	Width (mm)	Height (mm)	Capacity	Mounting	Item number
520	418	540	2x 33L	Door	607.8G05.366.174

· To suit 450mm cabinet width

520	418	620	2x 37L	Door	607.8G05.374.174
-----	-----	-----	--------	------	------------------

· To suit 450mm cabinet width

