

Sinkware & Appliances

Sinkware and Appliances

Product Guide

Tekform Sinkware

	Page
Information	11.4
Ergonomic Christchurch Range	11.6
Hand Fabricated Coloured (PVD) Range	11.9
Hand Fabricated Range	11.10
Composite Sink Range	11.11
Designer Butler Range	11.12
Everglades Range	11.13
Bowl & Drainer Range	11.15
Ergonomic Laundry Range	11.17
TradePro Sink & Tap	11.18
Sinkware Accessories	11.19

Tekform Tapware

Basin Mixers	11.23
Sink Mixers	11.24
High Rise Sink Mixers	11.25

Kitchen & Laundry Appliances

Information	11.30
Upright Cooker	11.31
Built-in Ovens	11.32
Compacts	11.36
Microwaves	11.39
Cooktops	11.40
Rangehoods	11.48
Dishwashers	11.58
Refrigeration	11.60
Outdoor Appliances	11.62
Washing Machines	11.63
Clothes Dryers	11.64

DOMUS Ducting

Information	11.65
Wall Outlets	11.66
SuperTube 125	11.67
EasiPipe	11.69
System Parts and Flexible Hoses	11.71
Pipe and Hose Accessories	11.73
Modular Kits	11.75

Tekform Sinkware

About your Tekform Sinkware

Stainless Steel Grade

Stainless steel is very hygienic and easy to clean, making it ideal for food preparation.

The regular steel grade is 304. Many Tekform sinks are available in the higher 316 marine grade steel.

Seamless Pressed Method

The superior finish of sinkware drawn from one solid plate takes skill and years of understanding the art of stainless steel.

Mercer, the manufacturer of Tekform sinks by Titus delivers this for you from their dedicated sinkware plant in Christchurch. Craftsmen with many combined years of experience produce your sinkware with care.

Radius

This is the measurement of the bowl curves. Tight radius bowls are squarer in shape, for a modern look. However the larger radius bowls are easier to clean and maintain.

Look out for these icons

A quick and easy way for you to understand which sink is right for your needs.

Sink Edge

For TopMount installations, the lip around the bowl can protect the high wear edge of your benchtop.

Size

Smaller bowls conserve water and bench space and are great for rinsing. Larger bowls will accommodate bigger dishes and trays.

Depth

Shallow bowls are perfect for food preparation and as an effective drainer. They leave plenty of room for underlying cabinetry and a great place to sit a dishrack.

Waste Location

The waste is often located towards the back of the sink to provide you with maximum storage space in the front of your kitchen cabinet.

Hand Welded Method (WI)

Also available in the range are entry level welded products. Still with the style and functionality you are looking for. Look for the 'Weld In' icon.

Edge Profile

There are a variety of edge profiles available. Rolled super-safe edges are robust and have no sharp edges, the flat profile chamfered edges on the Tekform pressed top-mount bowls are safe and unobtrusive with a tight fit to the bench surface. Chamfered edges create an easy to wipe with EzyWipe connection from the bench to the bowl.

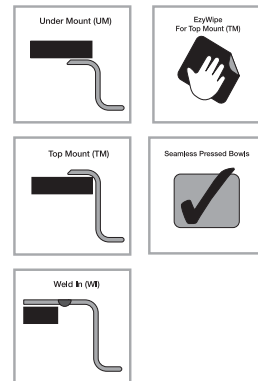

Note: UnderMount templates and CAD files are a guide only, we strongly recommend test cut-outs and check against actual bowls before installation.

Supplier Information and Warranty

Manufacture & Supply Partner

Titus Tekform's sinkware collection brings to the Australian market a unique range of products sourced and manufactured by our partner Mercer, from their modern pressing plant located in Christchurch, New Zealand.

Mercer brings major point of difference to the Sinkware market in Australia through Tekform by Titus, offering customers a variety of sinkware options for residential and industrial applications.

Mercer History



The original Mercer Company was established in 1884 by Mr James Mercer in Christchurch, New Zealand. James Mercer laid the foundations for the future with techniques in Copper-smithing, Metalworking and founder's hammer and forging.

Today, with over 130 years in operation, the modern facility has world standard deep-drawn tight radius pressing equipment, robotic polishing and annealing; which allows Mercer's long-term skilled employees to craft a range of uniformed deep-drawn stainless steel sinkware. Mercer is now part of the Acero Group and their full range of products can be viewed by visiting www.acero.co.nz

Product Disclaimer

As the Mercer policy is one of continual improvement, the manufacturers reserve the right to vary specifications or delete models from their range without prior notification.

Always use the physical product measurements for cut-outs as the manufacturer's template is a guide only and may differ from the actual product dimensions over time.

The manufacturers take no responsibility for printing errors.

Product Warranty

The Tekform by Titus range of stainless steel sinkware products carry a 25 year warranty for domestic application. Ceramic Butler sinks carry a 5 year warranty for domestic application. For information on commercial application warranties, speak to your sales representative.

Titus Tekform will rectify any genuine manufacturing fault found with any Tekform Sink by Titus during normal use. Please note that *this warranty does not cover scratching or normal wear and tear, as these are not manufacturing faults.*

Installation Reminder

Tekform sinkware can be installed in a variety of styles including TopMount and UnderMount. It is important to remember that all installations are to be carried out by trained cabinet makers familiar with the procedures involved.

Ceramic products in particular are to be fitted by specialist cabinet makers with the skills in fitting this type of sink design.

Need more technical information?

Log onto titustekform.com.au/products/kitchen-appliances/sinkware for specific product data sheets, care and maintenance information and product warranty details.

Tekform Sinkware

Ergonomic Christchurch (EC) Range

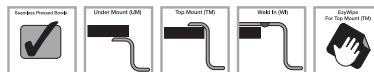

- Made in New Zealand
- 90mm round basket waste included
- 0.9mm, 304 grade stainless steel
- 15mm low profile EzyWipe flange
- Classic finish
- 50mm corner radius
- 25 year warranty



Technical details and dimensions

1/2 Bowl

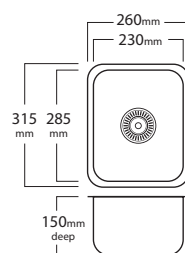

Length (mm)

Width (mm)

Depth (mm)

Capacity (L)

Item number

260 315 150 9 604.8E16.022.000

- Reversible
- 300mm minimum cabinet size

3/4 Bowl

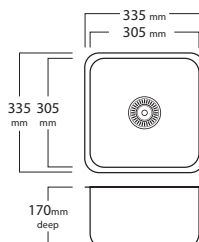

335 335 170 14 604.8E18.022.000

- Reversible
- 350mm minimum cabinet size

Medium Bowl

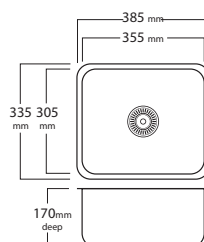

385 335 170 17 604.8E02.022.000

- Reversible
- 400mm minimum cabinet size

Main Bowl

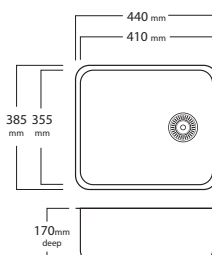







440 385 170 22 604.8E08.022.000

- Reversible
- 450mm minimum cabinet size

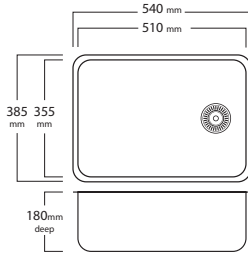
Accessories for EC Sinkware → See page 11.19

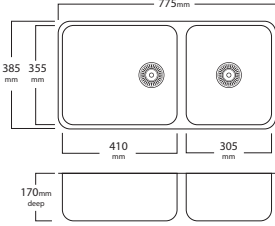
Tekform Sinkware

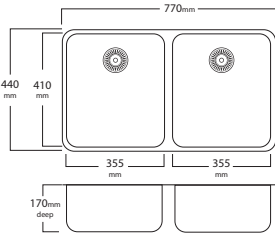
Ergonomic Christchurch (EC) Range

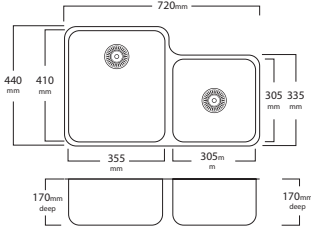
Technical details and dimensions		Length (mm)	Width (mm)	Depth (mm)	Capacity (L)	Item number
Maxi Bowl  		540	385	180	28	604.8E20.022.000 <ul style="list-style-type: none"> Reversible 550mm minimum cabinet size
Main Bowl & Medium Bowl  		775	385	170	22/17	604.8E22.022.000 <ul style="list-style-type: none"> Reversible 800mm minimum cabinet size
Double Main Bowls  		770	440	170	22/22	604.8E12.022.000 <ul style="list-style-type: none"> 800mm minimum cabinet size
Main Bowl & 3/4 Bowl  	RH Small Bowl LH Small Bowl	720	440	170	22/14	604.8E24.022.010
		720	440	170	14/22	604.8E24.022.020 <ul style="list-style-type: none"> 750mm minimum cabinet size

Tekform Sinkware

Ergonomic Christchurch (EC) Range

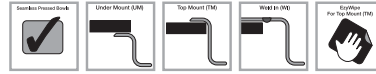

- Made in New Zealand
- 90mm round basket waste included
- 0.9mm, 304 grade stainless steel
- 15mm low profile EzyWipe flange
- Classic finish
- 50mm corner radius
- 25 year warranty

Technical details and dimensions		Length (mm)	Width (mm)	Depth (mm)	Capacity (L)	Item number
Main Bowl and 1/2 Bowl	RH Small Bowl	685	440	170	22/8L	604.8E21.022.100
	LH Small Bowl	685	440	170	8/22L	604.8E21.022.200

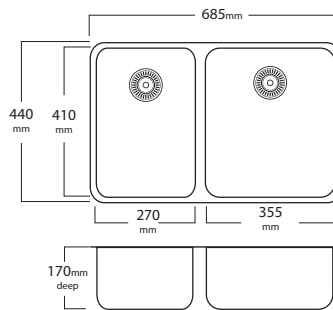

· 700mm minimum cabinet size

Accessories for EC Sinkware → See page 11.19

Tekform Sinkware

Hand Fabricated Coloured (PVD) Range

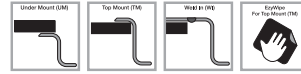

- Coloured using superior liquid-free Physical Vapour Deposition (PVD)
- 90mm colour-matched round basket waste included
- 1.2mm, 304 grade stainless steel
- 25mm flat flange
- Main bowl overflow
- 10mm corner radius
- 25 year warranty



Technical details and dimensions

Gun Metal

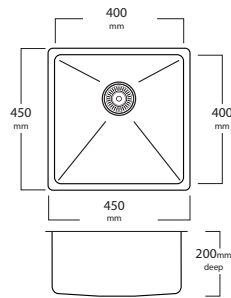

Length (mm)	Width (mm)	Depth (mm)	Capacity (L)	Item number
450	450	200	32	604.8140.022.005
550	450	200	40	604.8142.022.005

- Matching grid included
- Colour-matched taps available → see page 11.25

Brass

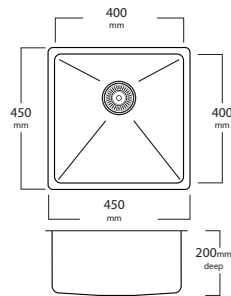

450	450	200	32	604.8140.022.006
550	450	200	40	604.8142.022.006

- Matching grid included
- Colour-matched taps available → see page 11.25

Copper

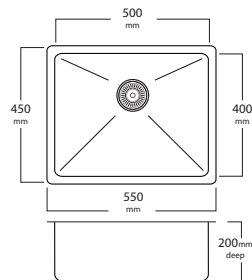
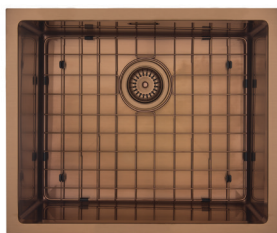

450	450	200	32	604.8140.022.007
550	450	200	40	604.8142.022.007





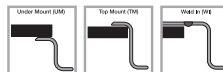

- Matching grid included
- Colour-matched taps available → see page 11.25

Tekform Sinkware

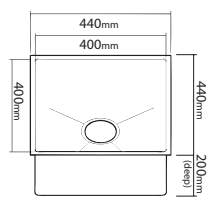
Hand Fabricated (HF) Range

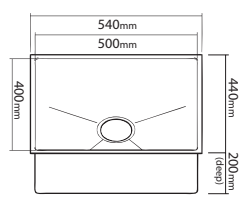

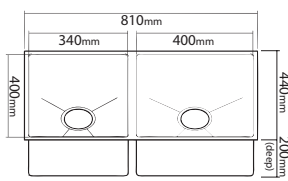
- 90mm round basket waste
- 1.2mm, 304 grade stainless steel
- 25mm flat flange
- Satin finish
- Main bowl overflow
- 15mm corner radius
- 25 year warranty

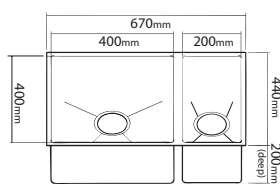
Technical details and dimensions		Length (mm)	Width (mm)	Depth (mm)	Capacity (L)	Item number
<p>Main Bowl</p>  		440	440	200	30	604.8I08.022.000
<ul style="list-style-type: none"> · 450mm minimum cabinet size 						
<p>Maxi Bowl</p>  		540	440	200	38	604.8I20.022.000
<ul style="list-style-type: none"> · 550mm minimum cabinet size 						
<p>Medium Bowl & Main Bowl</p>  		810	440	200	25/30	604.8I22.022.000
<ul style="list-style-type: none"> · 850mm minimum cabinet size 						
<p>Medium Bowl & 1/2 Bowl</p>  		670	440	200	30/11	604.8I33.022.000
<ul style="list-style-type: none"> · 700mm minimum cabinet size 						





Accessories for HF Sinkware → See page 11.19

Tekform Sinkware

Composite Sink (CM) Range

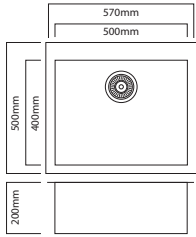

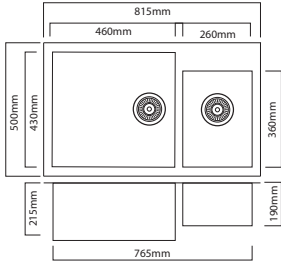
- Made in Italy
- 90mm round basket waste with cover
- 80% granite composite material
- 35mm flat flange
- Seamless matt finish
- Main bowl overflow
- 10mm corner radius
- 25 year warranty
- Tap holes not included

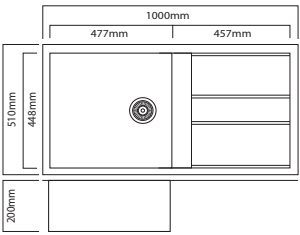
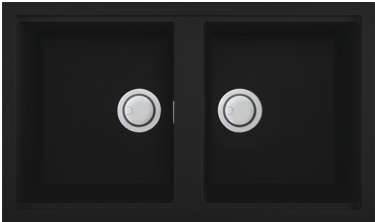
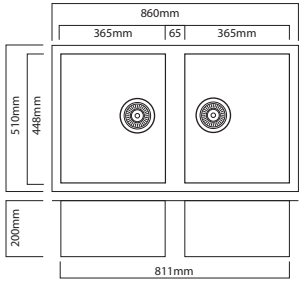
Technical details and dimensions		Length (mm)	Width (mm)	Depth (mm)	Capacity (L)	Item number
Large Bowl  		570	500	200	40	604.8J40.022.002 • 550mm minimum cabinet size
Main Bowl & 1/2 Bowl  		815	500	215	42/21	604.8J28.022.002 • 800mm minimum cabinet size
Main Bowl & Drainer  		1000	510	200	40	604.8J32.022.002 • Reversible • 600mm minimum cabinet size
Double Main Bowl  		860	510	200	31/31	604.8J30.022.002 • 900mm minimum cabinet size

Tekform Sinkware

Designer Butler (DB) Range



- Hand crafted in the UK from natural ceramic
- 90mm round basket waste
- High glaze white finish
- Main bowl overflow
- 5 year warranty



Technical details and dimensions

Ceramic Single Bowl

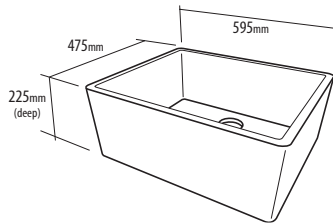

Length (mm)	Width (mm)	Depth (mm)	Capacity (L)	Item number
-------------	------------	------------	--------------	-------------

595	475	225	42	604.8L02.102.000
-----	-----	-----	----	-------------------------

- Ceramic bowls are not designed for a waste disposal
- Product tapers inward by 12mm from top to bottom on front and sides
- Ceramic products to be fitted by specialist
- All tap holes need to be cut by specialist. Tap holes are not included
- 600mm minimum cabinet size

Ceramic Double Bowl

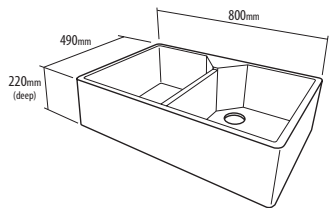

800	490	220	28/28	604.8L02.122.000
-----	-----	-----	-------	-------------------------



- Ceramic bowls are not designed for a waste disposal
- Product tapers inward by 12mm from top to bottom on front and sides
- Ceramic products to be fitted by specialist
- All tap holes need to be cut by specialist. Tap holes are not included
- 800mm minimum cabinet size

Tekform Sinkware

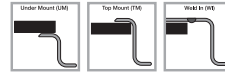
Everglades (EE) Range

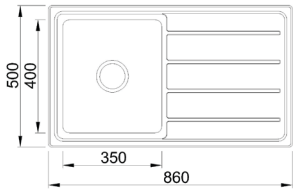

- 90mm round basket waste included
- 0.8mm, 304 grade stainless steel
- Silk finish
- Laser edge
- 25mm corner radius
- Main bowl overflow
- 25 year warranty

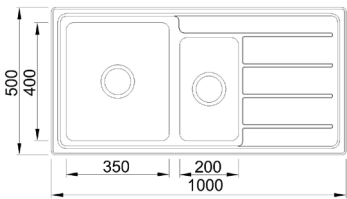
Technical details and dimensions		Length (mm)	Width (mm)	Depth (mm)	Capacity (L)	Item number	
Main Bowl with Drainer  		860	500	200	28	604.8030.022.006	
<ul style="list-style-type: none"> • Reversible • 450mm minimum cabinet size 							
Main Bowl and 1/4 Bowl with Drainer		RH Drain	1000	500	200/160	28/11	604.8031.022.206
		LH Drain	1000	500	160/200	11/28	604.8031.022.106
 		<ul style="list-style-type: none"> • 650mm minimum cabinet size 					



Tekform Sinkware

Everglades (EE)

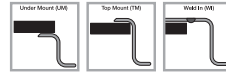
Range

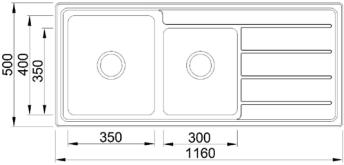

- 90mm round basket waste included
- 0.8mm, 304 grade stainless steel
- Silk finish
- Laser edge
- 25mm corner radius
- Main bowl overflow
- 25 year warranty

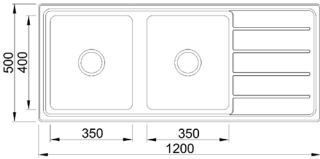

Technical details and dimensions		Length (mm)	Width (mm)	Depth (mm)	Capacity (L)	Item number
Main Bowl and 3/4 Bowl with Drainer  	RH Drain	1160	500	200/180	28/18	604.8034.022.206
	LH Drain	1160	500	180/200	18/28	604.8034.022.106
· 750mm minimum cabinet size						
Double Main Bowl with Drainer  		1200	500	200/200	28/28	604.8036.022.006

Tekform Sinkware

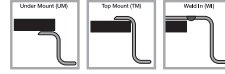
Bowl and Drainer (BD) Range

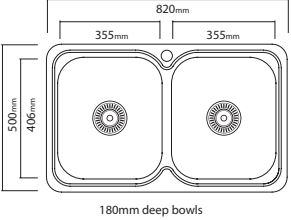

- 90mm round basket waste included
- 0.8mm, 304 grade stainless steel
- Satin finish
- Laser edge
- Main bowl overflow
- 25 year warranty

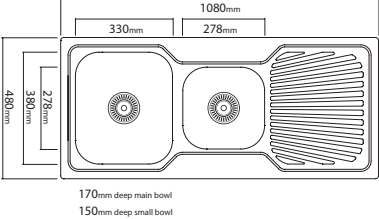
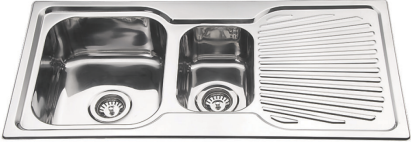
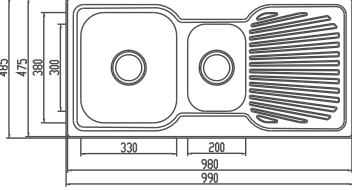

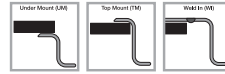

Technical details and dimensions		Length (mm)	Width (mm)	Depth (mm)	Capacity (L)	Item number
Double Bowls 	1 Tap Hole	820	500	180	24/24	604.8K12.022.100
	No Tap Hole	820	500	180	24/24	604.8K12.022.000
						
Main Bowl & 3/4 Bowl + Fan Drainer 	LH Drain 1 Tap Hole	1080	480	170/150	12/20	604.8K24.022.110
	RH Drain 1 Tap Hole	1080	480	170/150	20/12	604.8K24.022.120
	No Tap Hole	1080	480	170/150	20/12	604.8K24.022.000
						
Main Bowl & 1/2 Bowl + Fan Drainer 	No Tap Hole	990	485	170/150	20/8	604.8K28.022.000
						

Tekform Sinkware

Bowl and Drainer (BD) Range

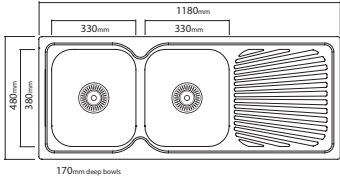

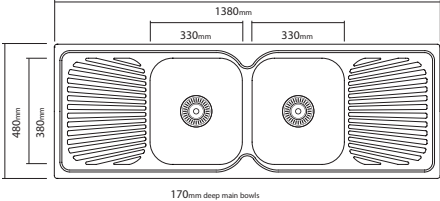
- 90mm round basket waste included
- 0.8mm, 304 grade stainless steel
- Satin finish
- Laser edge
- Main bowl overflow
- 25 year warranty

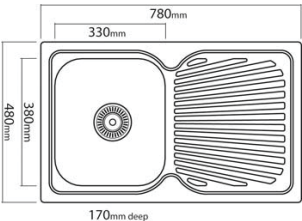



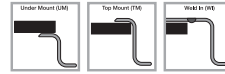

Technical details and dimensions		Length (mm)	Width (mm)	Depth (mm)	Capacity (L)	Item number
Double Bowls + Fan Drainer 	LH Drain 1 Tap Hole	1180	480	170	20/20	604.8K36.022.110
	RH Drain 1 Tap Hole	1180	480	170	20/20	604.8K36.022.120
	No Tap Hole	1180	480	170	20/20	604.8K36.022.000
						
Double Bowls + Double Fan Drainers 	1 Tap Hole	1380	480	170	20/20	604.8K46.022.000
	No Tap Hole	1380	480	170	20/20	604.8K46.022.100
						
Main Bowl + Fan Drainer 	LH Drain 1 Tap Hole	780	480	170	20	604.8K08.022.110
	RH Drain 1 Tap Hole	780	480	170	20	604.8K08.022.120
	No Tap Hole	780	480	170	20	604.8K08.022.000
						

Tekform Sinkware

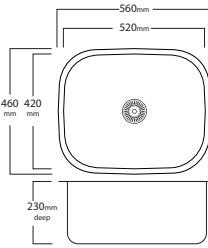
Ergonomic Laundry (EL) Range

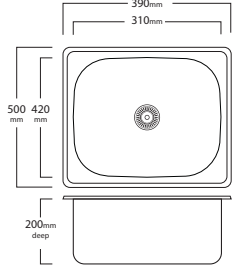

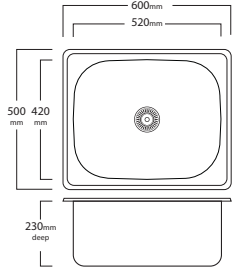
- Made in New Zealand
- 90mm round basket waste included
- 304 grade stainless steel

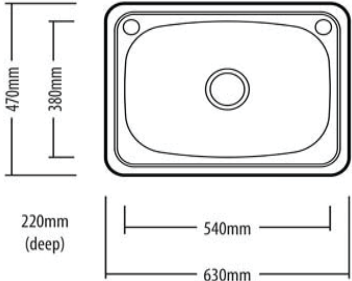
Technical details and dimensions		Length (mm)	Width (mm)	Depth (mm)	Capacity (L)	Item number	
Large Bowl 		560	460	230	45	604.8N40.022.000	
Laundry Tub 30L 		No Tap Hole	390	500	200	30	604.8N43.022.000
							
Laundry Tub 45L 		No Tap Hole	600	500	230	45	604.8N44.022.000
							
Premium Entry Level Laundry Tub 			630	470	220	45	604.8V44.022.001
							

Tekform Sinkware

TradePro Sink & Tap

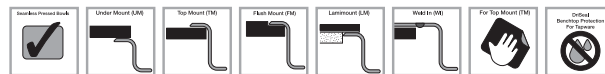

- Seamless pressed bowls
- 304 grade stainless steel
- Sidewall by-pass kit
- Large bowl kitchen, galley and alfresco applications

Technical details and dimensions

TradePro Main Bowl & 3/4 Bowl with Drainer and Mixer Tap

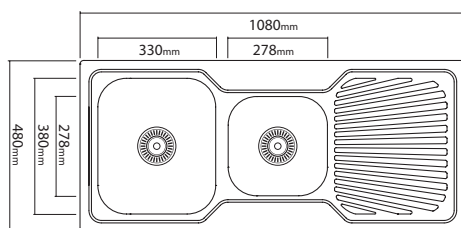
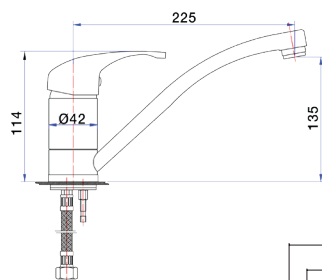

170mm deep main bowl
150mm deep small bowl

Length (mm)	Width (mm)	Depth (mm)	Capacity (L)	Item number
-------------	------------	------------	--------------	-------------

1080	480	170/150	20/11	604.8V52.022.001
------	-----	---------	-------	------------------

- Sink and tap package
- For sink only → 604.8V52.022.000

Tekform Sinkware Accessories

Information

Customise

Using foodboards, colanders and other fitted accessories with your sinkware makes food preparation simple.

See pages 11.20-11.22 to mix and match accessories with your preferred sink.

Drainer Trays

Drainer trays give you the option of placing the drainer where it is most convenient. Create bench space and drain wet dishes effortlessly with a drainer tray positioned left, right or fitted over your sink.



Food Preparation

Food boards are perfect for creating more bench space in smaller kitchens. Fit the cutting board over the sink to create a food preparation space.



Washing up

Tekform Sink accessories offer flexibility to your space. Add dishracks suited to your preferred sinks and cleaning up is easy.



DriSeal (DS) Program

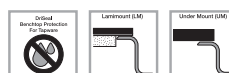
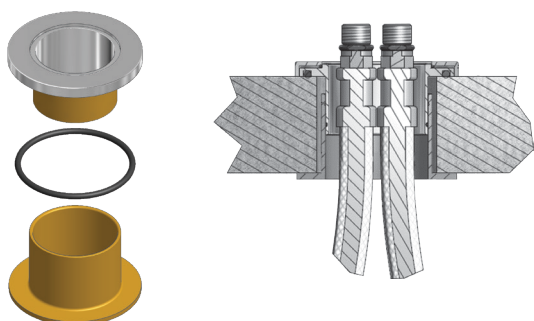



- To use with all sinkware without tap landings
- Protects benchtops from water damage
- Creates a barrier to spills and leaks
- Decorative and functional design

DriSeal product images and ordering information can be found under Sink Accessories (SA)

→ See page 11.22

Tekform Sinkware

Sink Accessories (SA)

	Item number
<p>Ergonomic Christchurch Food Board</p> 	<p>604.8X62.018.000</p> <ul style="list-style-type: none">· To suit EC Main Bowls
<p>Hand Fabricated Food Board</p> 	<p>604.8X54.143.000</p> <ul style="list-style-type: none">· To suit HF Main Bowls
<p>Bowl and Drainer Food Board</p> 	<p>604.8X54.270.000</p> <ul style="list-style-type: none">· To suit BD Main Bowls

Tekform Sinkware

Sink Accessories (SA)

Tekform Sinkware Accessories by Titus offer you:

- Convenience
- Organisation
- Flexibility
- Safety

	Item number
<p>Bowl & Drainer Tray</p> 	<p>604.8X60.034.000</p> <ul style="list-style-type: none"> · To suit BD Main Bowls
<p>Ergonomic Christchurch Drainer Tray</p> 	<p>604.8X60.032.000</p> <ul style="list-style-type: none"> · To suit EC Main Bowls
<p>Hand Fabricated Drainer Tray</p> 	<p>604.8X60.130.000</p> <ul style="list-style-type: none"> · To suit HF Main Bowls

Tekform Sinkware

Sink Accessories (SA)

Tekform Sinkware Accessories by Titus offer you:

- Convenience
- Organisation
- Flexibility
- Safety

	Item number
Dish Rack S/S (EC & BD Main Bowls)	604.8X62.024.000
	
Dish Rack S/S (DC & HF Main Bowls)	604.8X62.016.000
	
DriSeal Round	604.8X64.090.001
	
DriSeal Square	604.8X64.090.002
	

Tekform Tapware

Basin Mixers

- 40mm Ceramic Cartridge
- 5 star WELS water rating

Technical details and dimensions		Finish	Item number
<p>Square Basin Mixer</p>   <p>Made of brass with chrome</p>	Chrome	604.8F08.001	<ul style="list-style-type: none"> • Solid handle
<p>Basin Mixer</p>   <p>Made of brass with chrome</p>	Chrome	604.8F08.005	<ul style="list-style-type: none"> • Solid handle

Tekform Tapware

Sink Mixers

- 40mm Ceramic Cartridge
- 5 star WELS water rating

Technical details and dimensions

Single Lever Single Mixer

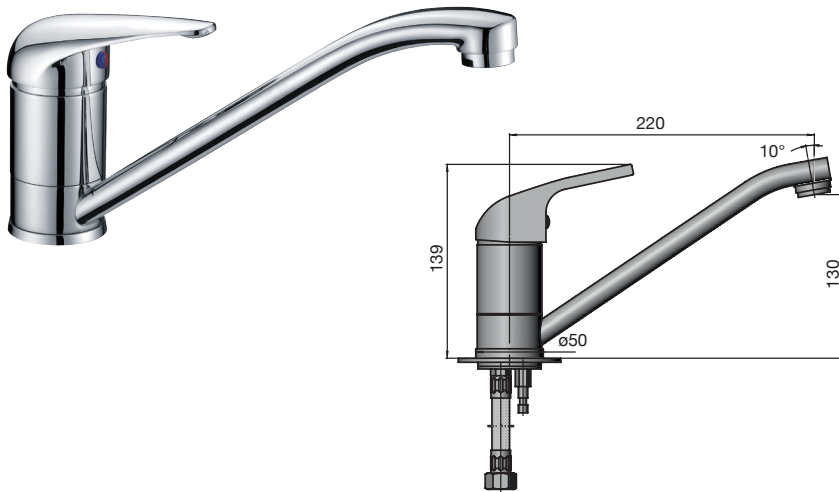

Made of brass with chrome

Pull-out Single Lever Sink Mixer

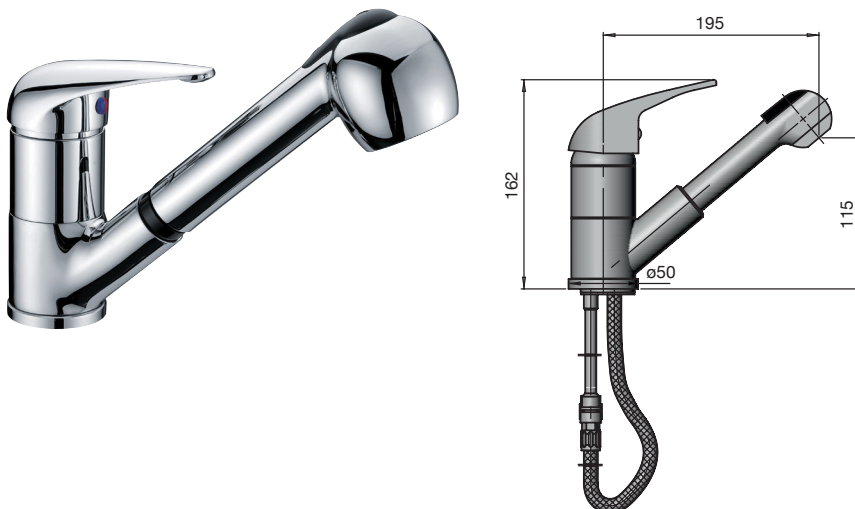

Made of brass with chrome

Finish

Item number

Chrome

604.8F07.050

- Solid handle

Chrome



604.8F07.055

- Solid handle

Tekform Tapware

High Rise Sink Mixers

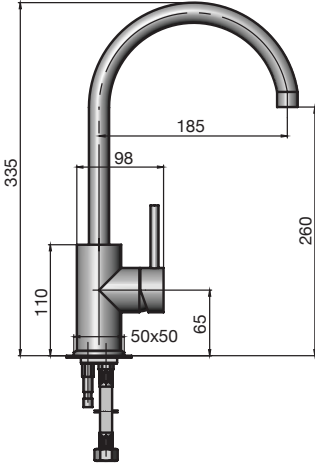

- 35mm Ceramic Cartridge
- 5 star WELS water rating

Technical details and dimensions		Finish	Item number
High Rise Goose Neck Sink Mixer  		Chrome Gun Metal Brass Copper	604.8F07.015 604.8F07.015.005 604.8F07.015.006 604.8F07.015.007
High Rise Square Neck Mixer  		Chrome	604.8F07.020
		• Pin handle	

Tekform Tapware

High Rise Sink Mixers

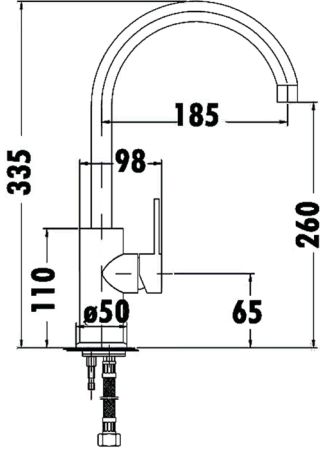
- 35mm Ceramic Cartridge
- 5 star WELS water rating

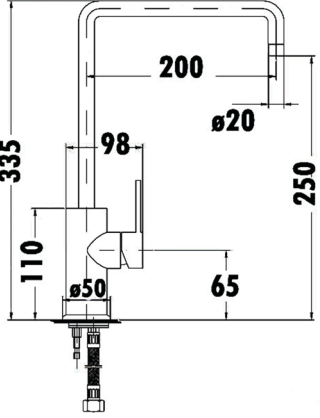
Technical details and dimensions		Finish	Item number
Black High Rise Goose Neck Sink Mixer		Matt Black	604.8F07.150.002
		<ul style="list-style-type: none"> • Pin handle 	
Black High Rise Square Sink Mixer		Matt Black	604.8F07.030.002
		<ul style="list-style-type: none"> • Pin handle 	

Tekform Tapware

High Rise Sink Mixers

- 35mm Ceramic Cartridge Goose Neck / 40mm Ceramic Cartridge Square
- 5 star WELS water rating

Technical details and dimensions		Finish	Item number
<p>High Rise Goose Neck Pull-out Sink Mixer</p>  		Chrome	604.8F07.025
		<ul style="list-style-type: none"> · Pull-out Pin handle 	
<p>High Rise Square Sink Mixer</p>  		Chrome	604.8F07.030
		<ul style="list-style-type: none"> · Single Lever handle 	

Tekform Tapware

High Rise Sink Mixer

- 40mm Ceramic Cartridge
- 5 star WELS water rating

Technical details and dimensions		Finish	Item number
High Rise Multi-function Sink Mixer		Chrome	604.8F07.010
		• Pull-out Pin handle	
Made of brass with chrome			

Kitchen & Laundry Appliances

Appliances from Titus Tekform

The Brands

Teka Appliance Collection - Global Solutions for Australian Homes



Founded in 1924, Teka has become the benchmark in European manufacture of built-in home appliances, particularly cooking. Today, Teka boasts more than 30 factories spread across three continents and markets to over 110 countries.

Titus Tekform's partner, Residentia, has worked with Teka's product engineers to design a product range across the Kitchen and Laundry categories specifically to suit the Australian and New Zealand consumer.

InAlto Appliance Collection - A Higher Level of Cooking

INALTO^o

The InAlto brand was created by Residentia through a singular desire: to establish a premium-level range of kitchen appliances able to deliver a superior cooking experience to Australian consumers.

The Titus Tekform offer was designed to eliminate shortcomings with today's major brands whilst drawing on European design trends.

Quality Assurance for your Inalto and Teka Appliances from Titus Tekform

The Residentia team are committed to ensuring all products meet and exceed all required standards and approvals and have engaged the services of independent experts both locally and internationally to ensure this is the case.

All manufacturing partners are regularly audited and pre-shipment inspections will also take place. Residentia employs the services of QA inspectors to perform inspections on products throughout the manufacturing process.

Bonus Warranty

Each new InAlto or Teka appliance is now available with a bonus warranty when registered online. A 2 year manufacturer's warranty for Inalto appliances and a 3 year manufacturer's warranty for Teka appliances is automatically applied as standard, from the date of purchase.

Simply register online within 90 days of purchase and Residentia will extend the manufacturer's warranty by 12 months for InAlto products and 24 months for Teka products, free of charge.

2 + 1
3 + 2

INALTO^o

Claims and Returns

All InAlto appliances purchased from Titus Tekform carry a 24 month supplier warranty.

In the rare event that you experience a product failure or fault, you can contact the Residentia support team on:
1311 HELP (4357)

Stock of all required spare parts to suit the InAlto appliances is available to ensure the service technician can fix any issue promptly.

For more information on the Titus Tekform Quality and Claims policies, visit
www.titustekform.com.au/warranty-and-services

Kitchen Appliances

Upright Cookers



- Premium quality stand-alone cooktop and oven
- Superb balance of technology, performance and safety
- Electric oven with 9 cooking functions
- 102L oven capacity with Rotisserie
- Cavity cooling system
- Triple glazed removable door
- Self-cleaning catalytic liners
- 2 + 1 year InAlto warranty

	Width (mm)	Depth (mm)	Height (mm)	Item number
<p>900mm Freestanding Oven with Gas Cooktop</p> 	896	595	856	<p>604.8A41.102.001</p> <ul style="list-style-type: none"> · 5 Italian made Defendi burners with electric under-knob ignition
<p>900mm Freestanding Oven with Ceramic Cooktop</p> 	895	595	856	<p>604.8A41.302.001</p> <ul style="list-style-type: none"> · 4 zone induction cooktop, including extender zone

Kitchen Appliances

Built-in Ovens

- Superb balance of technology, performance and safety
- Full featured electric oven
- 80L gross oven capacity
- Personal assistant with 20 recipes selects optimal cook settings by food type and size
- 3 + 2 year Teka warranty

	Width (mm)	Depth (mm)	Height (mm)	Item number
<p>600mm Stainless Steel Maestro Pyrolytic Oven</p> 	595	562	595	<p>604.8A61.404.100</p> <ul style="list-style-type: none"> · 12 functions including fan-forced · 4 inch TFT display · Digital thermostat with temperature regulation 30-270°C · Pyrolytic and Hydroclean cleaning system · Soft open and close door · Ring illuminated control knobs · Touch control programmable timer · Quad glazed door · Easy to remove door glass system · European energy class A+
<p>600mm Stainless Steel Maestro Oven</p> 	595	562	595	<p>604.8A61.404.102</p> <ul style="list-style-type: none"> · 12 functions including fan-forced · 4 inch TFT display · Digital thermostat with temperature regulation 30-270°C · Hydroclean cleaning system · Soft open and close door · Ring illuminated control knobs · Touch control programmable timer · Quad glazed door · Easy to remove door glass system · European energy class A+

Kitchen Appliances

Built-in Ovens



- Superb balance of technology, performance and safety
- Electric oven
- 80L gross oven capacity
- 3 + 2 year Teka warranty

	Width (mm)	Depth (mm)	Height (mm)	Item number
<p>600mm Stainless Steel 6 Function Hydroclean Oven</p> 	595	562	595	<p>604.8A61.404.001</p> <ul style="list-style-type: none"> · Hydroclean cleaning system · 6 cooking functions · Triple glazed removable door · European energy class A
<p>600mm Stainless Steel 9 Function Hydroclean Oven</p> 	595	562	595	<p>604.8A61.404.002</p> <ul style="list-style-type: none"> · Hydroclean cleaning system · 9 cooking functions · Triple glazed removable door · European energy class A+
<p>600mm Stainless Steel Multifunction Pyrolytic Oven</p> 	595	532	595	<p>604.8A61.404.003</p> <ul style="list-style-type: none"> · Hydroclean cleaning system · Pyrolytic cleaning system · 8 cooking functions · Quad glazed removable door · European energy class A+

Kitchen Appliances

Built-in Ovens

- Superb balance of technology, performance and safety
- Electric oven
- Triple glazed removable door

	Width (mm)	Depth (mm)	Height (mm)	Item number
900mm Stainless Steel Multifunction Hydroclean Oven 	890	538+22	480	604.8A61.404.004 <ul style="list-style-type: none"> · Hydroclean cleaning system · 91L gross oven capacity · 9 cooking functions · European energy class A+ · 3 + 2 year Teka warranty
600mm Stainless Steel Minute Timer Fan Forced Oven 	595	575	595	604.8A41.404.001 <ul style="list-style-type: none"> · 5 cooking functions · 85L gross capacity · Cavity cooling system · 120 minute minder timer · 2 + 1 year InAlto warranty
600mm Stainless Steel Programmable Timer Fan Forced Oven 	595	575	595	604.8A41.404.002 <ul style="list-style-type: none"> · 5 cooking functions · 85L gross capacity · Cavity cooling system · Programmable clock/timer · 2 + 1 year InAlto warranty

Kitchen Appliances

Built-in Ovens

- Superb balance of technology, performance and safety
- Electric oven
- Triple glazed removable door
- Cavity cooling system
- 2 + 1 year InAlto warranty

	Width (mm)	Depth (mm)	Height (mm)	Item number
<p>600mm Stainless Steel 9 Function Fan Forced Oven</p> 	595	575	595	<p>604.8A41.404.003</p> <ul style="list-style-type: none"> · 9 cooking functions · 85L gross capacity · Programmable clock/timer
<p>600mm Multifunction Double Oven</p> 	595	569	874	<p>604.8A41.404.004</p> <ul style="list-style-type: none"> · 12 cooking functions · 102L gross capacity (42L + 62L) · Programmable LED timer
<p>900mm Stainless Steel Fan Forced Oven</p> 	895	547	475	<p>604.8A41.404.005</p> <ul style="list-style-type: none"> · 9 cooking functions · 100L gross capacity · Programmable LED timer

Kitchen Appliances

Compact Appliances

- Superb balance of technology, performance and safety
- Compact luxury kitchen appliances
- 3 + 2 year Teka warranty

	Width (mm)	Depth (mm)	Height (mm)	Item number
<p>600mm Compact Pyrolytic Oven with Hydroclean</p> 	595	542	455	<p>604.8A62.004.001</p> <ul style="list-style-type: none"> · Pyrolytic & Hydroclean cleaning system · 45L gross oven capacity · Quad glazed removable door · 12 cooking functions · Personal assistant with 20 recipes · Digital thermostat with temperature regulation 30-270°C · European energy class A+
<p>600mm Stainless Steel Combination Steam Oven</p> 	595	542	455	<p>604.8A62.006.001</p> <ul style="list-style-type: none"> · Hydroclean PRO cleaning system · 16 cooking functions · 45L gross capacity · Triple glazed soft close door · Sterilisation and regeneration function · Personal cooking assistant with 20 recipes · Slow-cook function
<p>600mm Combination Microwave & Multifunction Oven</p> 	595	455	542	<p>604.8A62.008.001</p> <ul style="list-style-type: none"> · Hydroclean PRO cleaning system · 16 cooking functions · 41L gross capacity · Triple glazed soft close door · 2500W maxi grill · Personal cooking assistant with 20 recipes · Slow-cook function

Kitchen Appliances

Compact Appliances



- Superb balance of technology, performance and safety
- Compact luxury kitchen appliances
- 2 cup capacity
- 30 automatic programs
- 3 + 2 year Teka warranty

	Width (mm)	Depth (mm)	Height (mm)	Item number
Built-in Compact Grinder Coffee Machine 	595	455	413	604.8A62.010.001 <ul style="list-style-type: none"> · Pump power: 15 bar · 1.8L water tank capacity · 3x functions: coffee, steam, hot water · Integrated coffee grinder · Grinding coarseness regulator: 13 positions
Built-in Compact Pods Coffee Machine 	595	455	413	604.8A62.010.002 <ul style="list-style-type: none"> · Pump power: 15 bar · 1.8L water tank capacity · 3x functions: coffee, steam, hot water · Integrated pod system

Kitchen Appliances

Compact Appliances



- Superb balance of technology, performance and safety
- Compact luxury kitchen appliances
- 3 + 2 year Teka warranty

	Width (mm)	Depth (mm)	Height (mm)	Item number
Compact Vacuum Sealer 	595	542	455	604.8A62.012.001
				<ul style="list-style-type: none"> • Designed to pair with Teka compacts • Vacuum sealing machine • Kitchen scale with protective cover • Roll holder for aluminium film • Roll holder for transparent film • Self-closing and soft close
Warming Drawer 	595	557	140	604.8A69.001.001
				<ul style="list-style-type: none"> • Designed to pair with Teka compacts • Mark-free stainless steel finish • Includes anti-slip matt • 30-70°C temperature range • Ideal for heating plates, cups and cutlery

Kitchen Appliances

Microwaves

- Superb balance of technology, performance and safety
- Child safety lock
- Stainless steel cavity

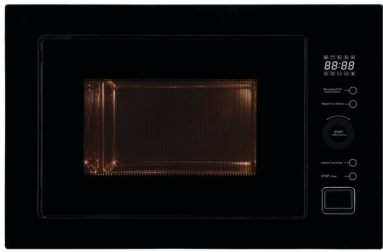
	Width (mm)	Depth (mm)	Height (mm)	Item number
<p>20L Built-in Microwave with Grill</p> 	595	325	390	604.8A62.008.100
	<ul style="list-style-type: none"> • 20L capacity • 5 power levels, 700W • Touch control panel with TFT display • 3 shortcut menus • 1 preset memory • Quartz grill, 1000W • 3 cooking modes • Automatic defrost options • Double glazed door • 3 + 2 year Teka warranty 			
<p>25L Built-in Microwave with Grill</p> 	595	390	380	604.8A62.008.200
	<ul style="list-style-type: none"> • 25L capacity • 5 power levels, 900W • Full touch control panel with TFT display • 8 shortcut menus • 1 preset memory • Quartz grill, 1000W • 3 cooking modes • Automatic defrost options • Double glazed door • 3 + 2 year Teka warranty 			
<p>25L Built-in Convection Microwave</p> 	594	465	388	604.8A42.008.001
	<ul style="list-style-type: none"> • 25L capacity • Frameless black glass built-in design • Defrost by weight and time • Touch controls • 900W microwave power • 1100W grill power • 2400W convection power • 2 + 1 year InAlto warranty 			

Kitchen Appliances

Aspirating Cooktop

- Fully integrated air suction system
- Capture fumes and odours in record time
- High performance ceramic filters
- Easy to clean
- Intuitive controls
- Available as either recycled (inner motor) or duct out (external motor)
- 5 year Elica warranty



Nikola Tesla Aspirating Cooktop & Integrated Rangehood





Installation mode	Width (mm)	Depth (mm)	Height (mm)	Item number
Ducted	830	515	210	604.8A83.020.001
Re-circulated	830	515	210	604.8A83.020.002

- 9 power levels
- Touch control
- Power booster
- Residual heat indicator
- Safe activation and child lock
- Safety shut down
- Cool induction surface

Kitchen Appliances

Induction Cooktops

- Superb balance of technology, performance and safety
- European made Eurokera glass
- Residual heat indicators
- Child lock
- Stop & Go function
- Powerplus boost function
- 3 + 2 year Teka warranty

	Width (mm)	Depth (mm)	Height (mm)	Item number
<p>600mm Extension Induction Cooktop</p> 	560	490	50	<p>604.8A63.016.001</p> <ul style="list-style-type: none"> · Bevelled edges · 3 cooking zones including 1 extension zone · Slide touch controls · Independent timer functions for each zone · Low temperature function
<p>800mm 4 Zone Induction Cooktop</p> 	800	510	50	<p>604.8A63.016.002</p> <ul style="list-style-type: none"> · Bevelled edges · 4 cooking zones · Slide touch controls · Independent timer functions for each zone · Pan detection system

Kitchen Appliances

Induction Cooktops

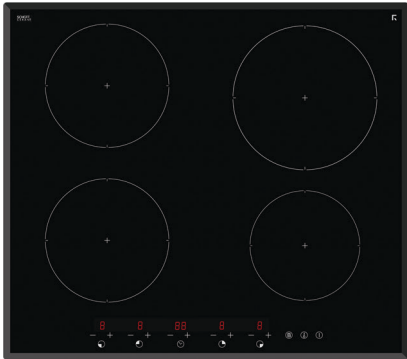

- Superb balance of technology, performance and safety
- Residual heat indicators
- Child lock

	Width (mm)	Depth (mm)	Height (mm)	Item number
<p>900mm 4 Zone Induction Cooktop</p> 	750	520	46	<p>604.8A63.016.003</p> <ul style="list-style-type: none"> · European made Eurokera glass · Bevelled edges · 4 cooking zones including flexi-zone · Slide touch controls · Independent timer functions for each zone · Pan detection system · Stop & Go function · Powerplus boost function · Teka Synchro function · 3 + 2 year Teka warranty
<p>600mm 4 Zone Induction Cooktop</p> 	590	520	56	<p>604.8A43.016.001</p> <ul style="list-style-type: none"> · Durable Schott Ceran glass · 4 cooking zones with boosters · Front touch control operation · Frameless with bevelled edges · High speed ribbon elements · 9 power levels · 99 min. zone timer · 2 + 1 year InAlto warranty

Kitchen Appliances

Gas Cooktops

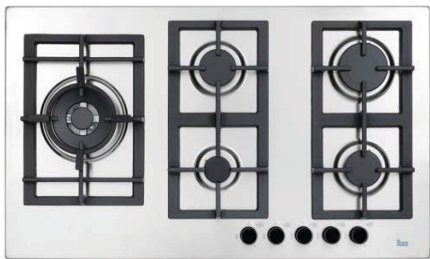

- Superb balance of technology, performance and safety
- Heavy duty cast iron trivets
- Automatic under-knob ignition
- Flame failure
- 3 + 2 year Teka warranty

	Width (mm)	Depth (mm)	Height (mm)	Item number
<p>600mm Stainless Steel Gas Cooktop</p> 	600	510	45	<p>604.8A63.014.001</p> <ul style="list-style-type: none"> • 4 burners including a wok burner • Easy to clean single press stainless steel hob
<p>900mm Stainless Steel Gas Cooktop</p> 	860	510	45	<p>604.8A63.014.002</p> <ul style="list-style-type: none"> • 5 burners including a wok burner • Easy to clean single press stainless steel hob
<p>600mm Ceramic Glass Gas Cooktop</p> 	610	512	50	<p>604.8A63.014.003</p> <ul style="list-style-type: none"> • Gas on glass cooktop • 4 burners including a triple ring wok burner • Easy to clean toughened ceramic glass

Kitchen Appliances

Gas Cooktops

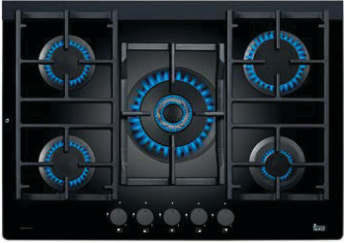

- Superb balance of technology, performance and safety
- Automatic under-knob ignition
- Flame failure

	Width (mm)	Depth (mm)	Height (mm)	Item number
<p>700mm Ceramic Glass Gas Cooktop</p> 	710	512	50	<p>604.8A63.014.004</p> <ul style="list-style-type: none"> · Gas on glass cooktop · Heavy duty cast iron trivets · 4 burners including a triple ring wok burner · Easy to clean toughened ceramic glass · 3 + 2 year Teka warranty
<p>900mm Ceramic Glass Gas Cooktop</p> 	860	510	45	<p>604.8A63.014.005</p> <ul style="list-style-type: none"> · Gas on glass cooktop · Heavy duty cast iron trivets · 4 burners including a triple ring wok burner · Easy to clean toughened ceramic glass · 3 + 2 year Teka warranty
<p>600mm 4 Burner Gas Cooktop</p> 	600	510	40	<p>604.8A43.014.001</p> <ul style="list-style-type: none"> · 4 Italian made Defendi burners · Heavy duty 304 grade stainless steel · Sturdy enamel trivets · Easy to clean single press stainless steel hob · 2 + 1 year InAlto warranty

Kitchen Appliances

Gas Cooktops

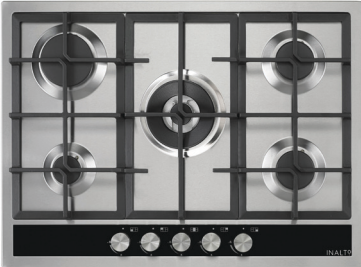
- Superb balance of technology, performance and safety
- Heavy duty 304 grade stainless steel
- Electronic under-knob ignition
- Flame failure
- Cast iron trivets
- 2 + 1 year InAlto warranty

	Width (mm)	Depth (mm)	Height (mm)	Item number
<p>600mm 4 Burner Side Control Gas Cooktop</p> 	600	510	40	<p>604.8A43.014.002</p> <ul style="list-style-type: none"> · 4 Italian made Defendi burners · Easy to clean single press stainless steel hob
<p>700mm 5 Burner Gas Cooktop</p> 	700	510	40	<p>604.8A43.014.003</p> <ul style="list-style-type: none"> · 5 Italian made Defendi burners · Easy to clean single press stainless steel hob
<p>900mm 5 Burner Gas Cooktop</p> 	860	510	40	<p>604.8A43.014.004</p> <ul style="list-style-type: none"> · 5 Italian made Defendi burners · Easy to clean single press stainless steel hob

Kitchen Appliances

Electric Cooktops

- Superb balance of technology, performance and safety
- 4 cooking zones
- Residual heat indicators
- Auto safety switch off
- 2 + 1 year InAlto warranty

	Width (mm)	Depth (mm)	Height (mm)	Item number
<p>600mm 4 Zone Knob Control Electric Cooktop</p> 	590	520	46	<p>604.8A43.018.001</p> <ul style="list-style-type: none"> · Durable Eurokera glass · Side knob control operation · Frameless · 6 power levels
<p>600mm 4 Zone Touch Control Electric Cooktop</p> 	590	520	46	<p>604.8A43.018.002</p> <ul style="list-style-type: none"> · Durable Schott Ceran glass · Front touch control operation · Frameless with bevelled edges · High speed ribbon elements · Child lock · 9 power levels · 99 min. zone timer

Kitchen Appliances

Electric Cooktops

- Superb balance of technology, performance and safety
- Residual heat indicators
- Auto safety switch off
- 2 + 1 year InAlto warranty

	Width (mm)	Depth (mm)	Height (mm)	Item number
<p>750mm 4 Zone Touch Control Electric Cooktop</p> 	750	520	46	<p>604.8A43.018.003</p> <ul style="list-style-type: none"> · Durable Schott Ceran glass · 4 cooking zones and 2 extended zones · Front touch control operation · Frameless with bevelled edges · High speed ribbon elements · Child lock · 9 power levels · 99 min. zone timer
<p>900mm 5 Zone Slide Control Electric Cooktop</p> 	900	520	56	<p>604.8A43.018.004</p> <ul style="list-style-type: none"> · Durable Schott Ceran glass · 3 extended zones · Front touch slide controls · Frameless with bevelled edges · High speed ribbon elements · Child lock · 9 power levels · 99 min. zone timer

Kitchen Appliances

Elica Rangehoods

- Ergonomic built-in configuration
- Capture fumes and odours in record time
- 3 speeds plus power booster
- 5 year Elica warranty



Adagio Stainless Steel Downdraft Rangehood



Pandora Stainless Steel Downdraft Rangehood



Meteorite Canopy Rangehood



Installation mode	Width (mm)	Depth (mm)	Height (mm)	Item number
Ducted	875	120	300	604.8A83.030.003
Re-circulated	875	120	300	604.8A83.030.004
<ul style="list-style-type: none"> • Motorised pop-up design • Touch control with optional remote control • 57 db(A) noise level • Aluminium grease filter • 800m³/h extraction capacity • Available as either recycled (inner motor) or duct out (external motor) 				
Ducted	758	120	140	604.8A83.030.001
Re-circulated	758	120	140	604.8A83.030.002
<ul style="list-style-type: none"> • Sleek integrated pop-up design • Touch control • 57 db(A) noise level • Aluminium and charcoal grease filter • 800m³/h extraction capacity • Available as either recycled (inner motor) or duct out (external motor) 				
Ducted	898	435	704	604.8A83.020.100
<ul style="list-style-type: none"> • Concealed filters • Touch control • 59 db(A) noise level • Aluminium grease filter • 880m³/h extraction capacity 				

Kitchen Appliances

Undermount Rangehoods

- Superb balance of technology, performance and safety
- Perimeter extraction undermount
- Strip LED lighting
- 1000m³/hr extraction
- Electric buttons with digital lighting
- Silent DC brushless motor
- 4 speeds
- 2 + 1 year InAlto warranty

	Width (mm)	Depth (mm)	Height (mm)	Item number
<p>520mm Digital Undermount Rangehood</p> 	520	295	308	604.8A64.026.001
<p>750mm Digital Undermount Rangehood</p> 	750	295	308	604.8A64.026.002
<p>900mm Digital Undermount Rangehood</p> 	900	295	308	604.8A64.026.003

Kitchen Appliances

Undermount Rangehoods

- Superb balance of technology, performance and safety
- Dishwasher safe aluminium grease filters
- LED lighting
- 750m³/hr extraction
- 2 + 1 year InAlto warranty

	Width (mm)	Depth (mm)	Height (mm)	Item number
520mm Undermount Rangehood 	520	296	282	604.8A44.026.001
750mm Undermount Rangehood 	750	296	282	604.8A44.026.002
900mm Undermount Rangehood 	900	296	282	604.8A44.026.003

Kitchen Appliances

Canopy Rangehoods

- Superb balance of technology, performance and safety
- LED lighting
- Digital touch control panel

	Width (mm)	Depth (mm)	Height (mm)	Item number
<p>900mm Box Canopy Rangehood</p> 	900	480	625-955	<p>604.8A64.020.001</p> <ul style="list-style-type: none"> · Perimeter extraction · Inner metallic grease filters · 4x LED lamps · Double turbine motor · 3 speeds + intensive mode · 3 + 2 year Teka warranty
<p>900mm Box Canopy Touch Rangehood</p> 	900	500	560	<p>604.8A44.020.005</p> <ul style="list-style-type: none"> · 1000m³/hr extraction · Stainless steel baffle filters · 3 speeds · Black glass fascia with touch controls · 2 + 1 year InAlto warranty
<p>900mm Island Canopy Rangehood</p> 	900	500	560	<p>604.8A44.020.006</p> <ul style="list-style-type: none"> · Island rangehood design · 1000m³/hr perimeter extraction · Stainless steel baffle filters · 4 speeds including turbo · Black glass fascia with touch controls · 2 + 1 year InAlto warranty

Kitchen Appliances

Canopy Rangehoods



- Superb balance of technology, performance and safety
- LED lighting
- Stainless steel baffle filters
- Digital touch control panel
- 2 + 1 year InAlto warranty

	Width (mm)	Depth (mm)	Height (mm)	Item number
900mm Box Canopy Rangehood 	900	500	548-1028	604.8A44.020.004 <ul style="list-style-type: none"> · 750m³/hr extraction · 2x LED lamps · 3 speeds · Push button controls
600mm Canopy Rangehood 	600	500	638-1018	604.8A44.020.001 <ul style="list-style-type: none"> · 1000m³/hr extraction · 4 speeds including turbo
900mm Canopy Rangehood 	900	500	638-1018	604.8A44.020.003 <ul style="list-style-type: none"> · 1000m³/hr extraction · 4 speeds including turbo

Kitchen Appliances

Canopy Rangehoods



- Superb balance of technology, performance and safety
- 1000m³/hr extraction
- LED lighting
- Digital touch control panel
- 3 speeds
- Black glass fascia
- 2 + 1 year InAlto warranty

	Width (mm)	Depth (mm)	Height (mm)	Item number
<p>600mm Curved Glass Canopy Rangehood</p> 	600	500	534-1014	604.8A44.020.002
<p>900mm Curved Glass Canopy Rangehood</p> 	900	500	570-1050	604.8A44.020.007
<p>900mm Flat Glass Canopy Rangehood</p> 	900	500	554-1034	604.8A44.020.008

Kitchen Appliances

Integrated Rangehoods

- Superb balance of technology, performance and safety
- Dishwasher safe aluminium grease filters
- LED lighting
- 1000m³/hr extraction
- 2 + 1 year InAlto warranty

	Width (mm)	Depth (mm)	Height (mm)	Item number
600mm Integrated Box Canopy Rangehood	565	285	352	604.8A44.020.009
				
900mm Integrated Box Canopy Rangehood	865	285	352	604.8A44.020.010
				

Kitchen Appliances

Slide-out Rangehoods

- Superb balance of technology, performance and safety
- Dishwasher safe aluminium grease filters
- LED lighting
- 440m³/hr extraction
- Ducted or recirculating installation options
- 2 speed settings
- 2 + 1 year InAlto warranty

	Width (mm)	Depth (mm)	Height (mm)	Item number
<p>600mm Slide-out Stainless Steel Rangehood</p> 	599	278	200	604.8A44.024.001
<p>900mm Slide-out Stainless Steel Rangehood</p> 	900	278	176	604.8A44.024.002

Kitchen Appliances

Fixed Rangehoods

- Superb balance of technology, performance and safety
- Dishwasher safe aluminium grease filters
- LED lighting
- 300m³/hr extraction
- Glass visor

	Width (mm)	Depth (mm)	Height (mm)	Item number
<p>600mm Fixed White Rangehood</p> 	600	500	140	<p>604.8A44.025.001</p> <ul style="list-style-type: none"> · White finish
<p>600mm Fixed Stainless Steel Rangehood</p> 	600	500	140	<p>604.8A44.025.002</p> <ul style="list-style-type: none"> · Stainless steel fascia

Kitchen Appliances

Rangehood Accessories

- Ensure your exhaust is ducted properly with a flu extension
- Use extension with canopy rangehoods

		Item number
<p>Rangehood Flu Extensions, 1200mm</p>  <p>Made of stainless steel</p>		604.8A44.028.001
		· For use with → canopy rangehoods 604.8A44.020.001 & 604.8A44.020.002
		604.8A44.028.002
	· For use with → canopy rangehood 604.8A44.020.004 & 604.8A44.020.005	
		604.8A44.028.003
	· For use with → canopy rangehood 604.8A44.020.002 & 604.8A44.020.007	

		Item number
<p>Rangehood Carbon Filter</p>  <p>Made of plastic and carbon mesh</p>		604.8A44.028.004
		· Designed to replace dirty carbon filters in your rangehoods

Kitchen Appliances

Dishwashers

- Superb balance of technology, performance and safety
- Delay start
- Height adjustable upper baskets
- Stainless steel micro filter
- Quiet operation
- Child lock

	Width (mm)	Depth (mm)	Height (mm)	Item number
600mm Teka Stainless Steel Multifunction Dishwasher 	598	610	845	604.8A65.030.002 <ul style="list-style-type: none"> · 14 place settings · Third cutlery drawer · 7 wash programs · 3.5 star energy rating · 4.5 star WELS water rating · Water leak, overflow and aquastop protection · 3 + 2 year Teka warranty
600mm Inalto Stainless Steel Multifunction Dishwasher 	598	610	845	604.8A45.030.003 <ul style="list-style-type: none"> · 14 place settings · Third cutlery drawer · 7 wash programs · 3.5 star energy rating · 4.5 star WELS water rating · Water leak, overflow and aquastop protection · 2 + 1 year InAlto warranty
600mm Inalto Stainless Steel Dishwasher 	600	580	850	604.8A45.030.001 <ul style="list-style-type: none"> · 14 place settings · Removable cutlery basket · 4 wash programs · 3 star energy rating · 4.5 star WELS water rating · Anti-leak and anti-flood devices · 2 + 1 year InAlto warranty

Kitchen Appliances

Dishwashers

- Superb balance of technology, performance and safety
- Delay start
- Height adjustable upper baskets
- Stainless steel micro filter
- Child lock
- 2 + 1 year InAlto warranty

	Width (mm)	Depth (mm)	Height (mm)	Item number
<p>600mm Integrated Dishwasher</p> 	598	550	815-865	<p>604.8A45.032.001</p> <ul style="list-style-type: none"> · 14 place settings · Fully integrated installation · Third cutlery drawer · 6 wash programs · 3 star energy rating · 4 star WELS water rating · Anti-leak, anti-flood and aquastop devices · Easy to clean slimline control panel · Door front not included
<p>450mm Stainless Steel Multifunction Freestanding Dishwasher</p> 	448	600	845	<p>604.8A45.030.002</p> <ul style="list-style-type: none"> · 10 place settings · Third cutlery drawer · 7 wash programs · 3.5 star energy rating · 3.5 star WELS water rating · Anti-leak and anti-flood devices

Kitchen Appliances

Refrigeration

- Superb balance of technology, performance and safety
- Frost-free
- Electronic LED display
- Interior LED lighting
- 2 + 1 year InAlto warranty

	Width (mm)	Depth (mm)	Height (mm)	Item number
545L Stainless Steel French Door Refrigerator 	833	740	1775	604.8A68.046.001 <ul style="list-style-type: none"> · 343L fridge volume · 202L freezer volume · Rapid freezing and cooling functions · Dual cycle/air cooled refrigeration system · Multi air flow · Recessed handle
244L Integrated Refrigerator 	540	540	1770	604.8A68.046.002 <ul style="list-style-type: none"> · 185 fridge volume · 59L freezer volume · Easy-fit integrated design · Easy-slide temperature control · Effective ventilation · Frost-free freezer

Kitchen Appliances

Refrigeration

- Touch key control panel
- Blue LED interior light
- Triple glazed tinted door
- Stainless steel reversible door
- 2 + 1 year InAlto warranty

	Width (mm)	Depth (mm)	Height (mm)	Item number
46 Bottle Wine Chiller 	595	564	820	604.8A53.001.001 <ul style="list-style-type: none"> · 145L/46 bottle capacity · Dual temperature zones · 6 wooden beech shelves with stainless steel trim
178 Can Beverage Centre 	595	564	820	604.8A53.001.002 <ul style="list-style-type: none"> · 145L/178 can capacity · Single temperature zone · 3 metal shelves with wooden trim

Outdoor Appliances

BBQ and Patio

- Premium 304 grade stainless steel
- Suitable for outdoor use
- 2 + 1 year InAlto warranty

	Burners	Width (mm)	Depth (mm)	Height (mm)	Item number
Outdoor Beverage Centre 		555	500	840	604.8A53.060.001
					<ul style="list-style-type: none"> · 118L/178 can capacity · 0°-10° temperature range · Tropical rated up to 43°C · Seamless stainless steel framed glass door · Triple glazed and heated glass · Electronic controls · Internal LED strip lighting · Weather resistant IPX4 rated
Outdoor Dual Motor Barbeque Rangehood 		1200	700	1279	604.8A44.060.001
					<ul style="list-style-type: none"> · Sturdy push button controls · 6 rotatable LED lights · 8 dishwasher safe baffle filters · 3 speed settings · Powerful 2000m³/hr air flow
Built-in Barbeque Grill 	4 Main Burners	945	523	850	604.8A55.060.001
	6 Main Burners	945	523	850	604.8A55.060.002
					<ul style="list-style-type: none"> · Internal lighting · LED illuminated control knobs · Heavy duty flame diffusers · Double-sided cast iron plate · Stainless steel cooking grid · Temperature gauge · Grease tray · Rotisserie · Infrared rear burner

Laundry Appliances

Front Load Washers

- 16 programs
- Delay start
- LED display
- 15 minute Quick Wash
- 4 star WELS water rating
- 3 + 2 year Teka warranty

	Capacity (kg)	Width (mm)	Depth (mm)	Height (mm)	Item number
<p>Front Load Washing Machine</p> 	10	595	595	850	604.8A66.034.002
	<ul style="list-style-type: none"> • Spin speed selector • Pre-wash option • Teka Speed Wash technology • 'Add a garment' feature • Water temperature control • 3.5 star energy rating 				
<p>Combination Front Load Washing Machine & Dryer</p> 	10/7	595	565	850	604.8A66.038.002
	<ul style="list-style-type: none"> • 10kg washing capacity • 7kg drying capacity • Spin speed selector • Pre-wash option • Teka Speed Wash / Dry program • 'Add a garment' feature • Water temperature control • Condenser dryer • Condensation expelled through drain hose • 3 star energy rating 				

Laundry Appliances

Clothes Dryers

- Delay start
- Removable lint filter
- Auto power off
- Anti-crease mode
- Child lock
- 3 + 2 year Teka warranty

	Width (mm)	Depth (mm)	Height (mm)	Item number
7kg Heat Pump Dryer 	595	622	845	604.8A67.042.001
	<ul style="list-style-type: none"> · 7kg clothes capacity · 16 drying programs · Autosensing drying · Water tank display · 375mm door opening · LED display · 198 min. full load standard dry time · Transparent door · Reverse tumbling action · 6 star energy rating 			

Ducting and Ventilation Product Range

Supertube 125



Supertube 125 is ideal for the ducting of all rangehoods and powerful fans. The airflow efficiency of Supertube 125 is maintained even on long ducting runs and can be used with appliances of high extraction rates.

EasiPipe



EasiPipe round ducting is available in two diameters: 125 and 150mm. EasiPipe is a multi-application system and is ideal for larger fans, rangehoods, whole-house ventilation systems, stack ventilation and air conditioning.

A round pipe system represents the most efficient air flow conduit as less air turbulence occurs.

Hoses & Accessories



Flexible hoses provide a solution to overcome situations where a rigid component cannot be installed. Manufactured in PVC self-extinguishing material or polyester coated aluminium for extra strength. Hoses are mainly for use with tumble dryers or when there is slow moving air. Round hoses are available in sizes which are compatible with both of our ranges in various standard lengths.

A selection of accessories including hose connectors, clips and tape provide effective connections from flexible to rigid ducting.

Wall Outlets



DOMUS Ducting manufacture a comprehensive range of wall outlets, which are fully compatible with all DOMUS system configurations. A choice of three round spigots to fit all EasiPipe sizes and rectangular sockets for use with Supertube 125 are available.

Wall outlets are manufactured in White UV stabilised finishes. There are various types of outlets for use in different situations.

Kits

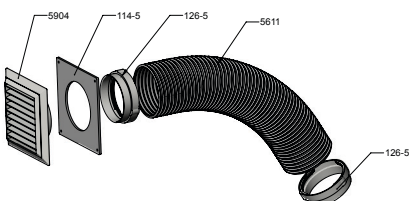

A range of standard boxed kits is available providing a one-stop solution to many popular installation requirements.

However, should these kits not provide the necessary products, special kits can be designed to meet the exact specification of the installation. All are packed in purpose made cartons.

Ducting

Wall Outlets and Ventilators

- UV stabilised plastic
- Protection from vermin and pests





	Outer Diameter (mm)	Outer Width x Height (mm)	Item number
Wall Outlet with Gravity Flaps 	125	200 x 200	604.8C06.590.000
	150	200 x 200	604.8C06.690.000
Louvred Grill with Flyscreen 	125	200 x 200	604.8C06.594.000
	150	200 x 200	604.8C06.694.150
Brick Size Wall Outlet 		201 x 57	604.8C06.501.000
			· Brick sized wall outlet for use with 515 flat channel

Ducting

SuperTube 125

Flat Modular Ducting

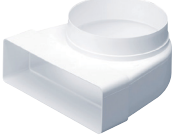
- Creates efficient air flow
- Ideal for use with larger fans and rangehoods

		Outer Diameter (mm)	Outer Width x Height (mm)	Inner Width x Height (mm)	Length (mm)	Item number
Flat Channel			204 x 60		1500	604.8C04.515.000
Flat Channel Clip			204 x 60			604.8C04.122.000
Flat Channel Connector	Without damper 			204 x 60		604.8C04.520.000
Elbow Bend		125		204 x 60		604.8C04.540.000
		150		204 x 60		604.8C04.640.000
Vertical 90° Bend			204 x 60			604.8C04.560.000

Ducting

SuperTube 125

Flat Modular Ducting

	Outer Width x Height (mm)	Outer Diameter (mm)	Inner Width x Height (mm)	Item number
Adapter 		125	204 x 60	604.8C04.570.000
Horizontal 90° Bend 			204 x 60	604.8C04.550.000
Adapter with Offset Centres 	262 x 118		205 x 61	604.8C06.115.000 <ul style="list-style-type: none"> Rectangular Wall Plate 115 for use with brick size wall outlet.
Adjustable Horizontal Bend 	201 x 57		204 x 60	604.8C04.545.000 <ul style="list-style-type: none"> Adjustable to and from 3.75° - 48.75°

Ducting

EasiPipe Round Modular Ducting



- Available in both 125mm and 150mm diameter
- Very efficient with low turbulence
- Flexible usage with multiple applications

	Outer Diameter (mm)	Item number
Right Angle Bend 	125	604.8C02.590.000
	150	604.8C02.690.000
Straight Pipe Connector 	125	604.8C02.593.000
	150	604.8C02.693.000

Ducting

EasiPipe Round

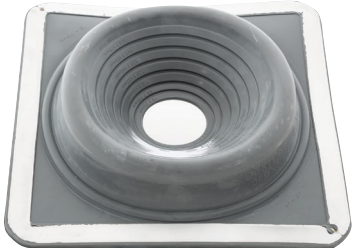
Modular Ducting

		Inner Diameter (mm)	Item number
Deklite® Flashing on Lead	Deklite original	75-160	604.8C02.104.000
	Deklite Tile on lead	75-160	604.8C02.114.000
			
Roof Cowl		125	604.8C02.505.000
		150	604.8C02.507.000
			

Ducting



System Parts and Flexible Hose

	Outer Diameter (mm)	Inner Diameter (mm)	Length (mm)	Item number
Pipe Fastener 	125			604.8C02.596.150
	150			604.8C02.696.150
EasiPipe 		125	1200	604.8C02.530.000
		150	1000	604.8C02.110.000

Ducting



System Parts and Flexible Hose

- For usage where rigid piping cannot be installed
- Suitable for slow air movement
- Ideal for clothes dryer installations

	Inner Diameter (mm)	Length (mm)	Item number
Round PVC Coated Flexible Hose	127	1000	604.8C02.561.000
			
Round Nude Aluminium Hose	127	3000	604.8C02.905.000
			
	150	3000	604.8C02.906.000



Ducting

Pipe and Hose Accessories

		Outer Diameter (mm)	Inner Diameter (mm)	Item number
Circular Reducer and Adapter 	Adapter	125	150	604.8C02.118.000
	Reducer	125	100	604.8C02.119.000
<p>These products can be fitted together to form either a 125-100mm adapter or a 125-150mm reducer.</p>				
Threaded Hose Connector with Socket 			125	604.8C02.125.150
			150	604.8C02.126.000

Ducting

Pipe and Hose Accessories

	Inner Diameter (mm)	Outer Width x Height (mm)	Length (m)	Item number
<p>Cable Tie</p> 	150			604.8C02.125.000
<p>PVC Duct Sealing Tape</p> 			4.6	604.8C02.123.000
<p>Round Wall Plate</p> 	125	154 x 154		604.8C02.145.000
	150	205 x 205		604.8C02.146.000

Ducting

Modular Ducting Kits

- Complete solutions for popular installations
- Available as boxed kits

	Item number
<p>Supertube 125 Ducting Kit for 125mm Diameter</p>	604.8C08.225.000
<p>Supertube 125 Ducting Kit for 150mm Diameter</p>	604.8C08.226.000
<p>Flexible Hose Ducting Kit for Rear Ducting 125mm Diameter</p>	604.8C08.215.000