

Doors, Panels & Surfaces

Doors & Panels

Product Guide

Stefano Orlati Solid Surfaces

	Page
OptiGlaz Gloss Acrylic Board	12.4
OptiMatt PET Matt Board	12.6
Chiara 100% Acrylic Benchtops	12.8
Metalamines and HMR Particle Board	12.10

Duraform® Vinyl Wrapped Doors

Series One - Contemporary Soft Corners	12.11
Series Two - Sharp Lines	12.12
Series Three - Square Corners and Defined Lines	12.13
Series Four - Classical Country	12.14
Series Five - Raised Designs	12.15
Options and Accessories	12.16
Ordering Information	12.20

Alifrost® Aluminium Doors

Product Overview and Application	12.21
Frame Options	12.22
Ali Handle	12.24
Insert Options	12.25
Extras and Accessories	12.27
Ordering Information	12.27

Belle Roller Doors

Product Overview and Specification	12.28
Ordering Information	12.29

Opti Board Product Overview

The Stefano Orlati OptiGlaz and OptiMatt board range offers interior designers, specifiers and architects a selection of high gloss and matt doors and panels to beautifully finish any kitchen or room design.

- OptiGlaz high gloss acrylic board is bonded to select grade MDF substrate using PUR hotmelt lamination technology
- OptiMatt PET board is manufactured from thermoformed Polyethelene Terephthalate for a safe, non-toxic, strong and lightweight material that is 100% recyclable
- The Opti Board range is available in sheets or can be prefabricated to your specifications
- Colour-matched edgebanding available → see page 6.3



OptiGlaz

Gloss Acrylic Board

Designed for vertical surface applications, OptiGlaz offers an easy-clean, superior high gloss mirror-like finish for drawers, door fronts and joinery.

OptiGlaz

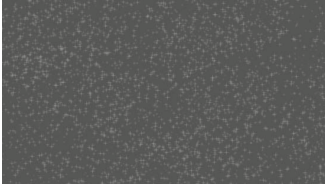

Anthracite Pearl



Champagne Pearl

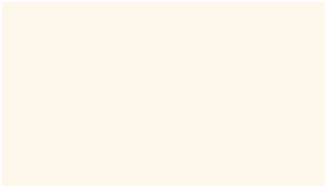

Cream

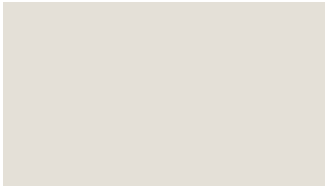

Great White



Ice White

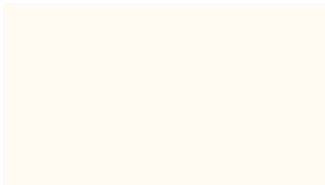

Ivory

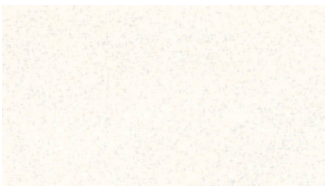

Ivory Pearl

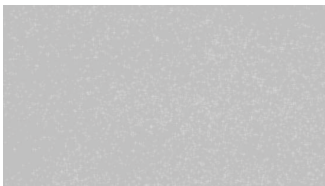

Silver Pearl

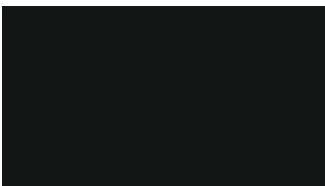

Super Black

OptiGlaz

Gloss Acrylic Board

- Ultra high gloss ripple-free surface
- UV and colour fade protected
- High scratch resistance
- Won't chip, crack or delaminate
- 9 double-sided finishes with matching edgebanding
- Non-directional metallics
- Single-sided with matching melamine back available in white and black

OptiGlaz Acrylic Board



Colour	Length (mm)	Width (mm)	Thickness (mm)	Item number
Ice White	2440	1220	18.2	602.8026.120.001
Super Black	2440	1220	18.2	602.8026.120.002
Ivory	2440	1220	18.2	602.8026.120.003
Cream	2440	1220	18.2	602.8026.120.004
Great White	2440	1220	18.2	602.8026.120.005
Silver Pearl	2440	1220	18.2	602.8026.120.006
Champagne Pearl	2440	1220	18.2	602.8026.120.007
Ivory Pearl	2440	1220	18.2	602.8026.120.008
Anthracite Pearl	2440	1220	18.2	602.8026.120.009
Ice White	3040	1220	18.2	602.8031.120.001

For complementary edgebanding
see pages → 6.3 - 6.5

OptiMatt

PET Matt Board

Designed for vertical surface applications, OptiMatt offers an easy-clean, superior velvet-like finish for cabinetry and furniture applications.

OptiMatt



Anthracite



Black

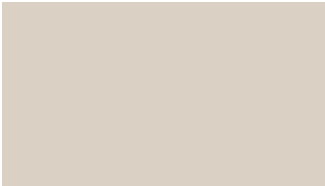

Cashmere



Dove Tale

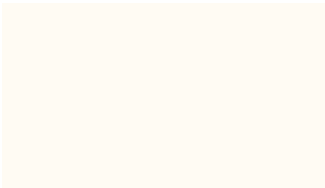

Ivory

White

OptiMatt

PET Matt Board

- Fingerprint-resistant surface
- Made from recyclable PET
- High scratch resistance
- Won't chip, crack or delaminate
- Features double-sided decors

	Colour	Length (mm)	Width (mm)	Thickness (mm)	Item number
<p>OptiMatt PET Board</p> 	White	2440	1220	18.2	602.8024.120.001
	Black	2440	1220	18.2	602.8024.120.002
	Ivory	2440	1220	18.2	602.8024.120.004
	Cashmere	2440	1220	18.2	602.8024.120.007
	Dove Tale	2440	1220	18.2	602.8024.120.025
	Anthracite	2440	1220	18.2	602.8024.120.027
	White	3040	1220	18.2	602.8030.120.001
	Black	3040	1220	18.2	602.8030.120.002
	Ivory	3040	1220	18.2	602.8030.120.004
	<p>For complementary edgebanding see pages → 6.3 - 6.5</p>				

Stefano Orlati Chiara 100% Acrylic Benchtops

The Chiara benchtop is easily fabricated to your specifications and supremely low maintenance. All 11 finishes are factory machined and ready to finish any kitchen.

Colour Options:



Amalfi

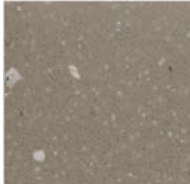

Palmanova

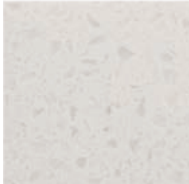

Manarola

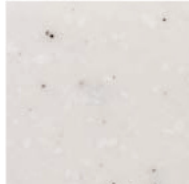

Lecce



Ravello

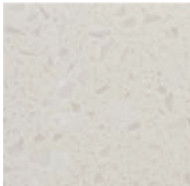

Sorrento



Atrani

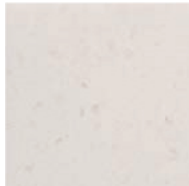

Portofino

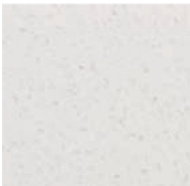

Cefalu



Positano

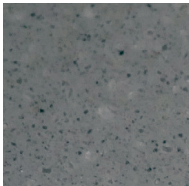

Domaso

Custom Edge Profiles:

Pencil Round



Arriss



Waterfall

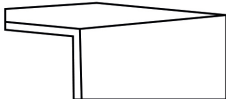

Stefano Orlati Chiara 100% Acrylic Benchtops

- More versatile than granite or marble
- Strong, cool-touch material with inconspicuous joins
- 12mm solid colour surface
- 10 year warranty

	Colour	Length (mm)	Width (mm)	Thickness (mm)	Item number
Chiara Acrylic Benchtops 	Manarola	3660	760	12.3	602.8027.360.001
	Positano	3660	760	12.3	602.8027.360.002
	Sorrento	3660	760	12.3	602.8027.360.003
	Portofino	3660	760	12.3	602.8027.360.004
	Ravello	3660	760	12.3	602.8027.360.005
	Amalfi	3660	760	12.3	602.8027.360.006
	Atrani	3660	760	12.3	602.8027.360.007
	Cefalu	3660	760	12.3	602.8027.360.008
	Palmanova	3660	760	12.3	602.8027.360.009
	Lecce	3660	760	12.3	602.8027.360.010
	Domaso	3660	760	12.3	602.8027.360.011
	50ml Solid Surface Adhesive	Manarola			
Positano					602.8028.050.002
Sorrento					602.8028.050.003
Portofino					602.8028.050.004
Ravello					602.8028.050.005
Amalfi					602.8028.050.006
Atrani					602.8028.050.007
Cefalu					602.8028.050.008
Palmanova					602.8028.050.009
Lecce					602.8028.050.010
Domaso					602.8028.050.011
Colour matched adhesive for seamless joins with the Chiara 100% Acrylic Benchtops					

Doors & Panels

Stefano Orlati Metalaminates & HMR Particleboard

Product Overview

- A durable, non-staining, non-marking material that is ideal for kickers & feature panels
- Available in two colours: Brushed Aluminium & Brushed Stainless Steel
- Premounted large sheets & smaller width ribs on HMR particleboard available for ease of installation & use in moisture prone areas such as kitchens & bathrooms

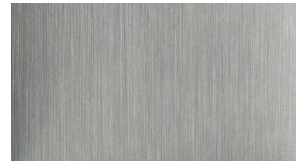

Product ordering information

	Item number
Brushed Aluminium Metalamine 3600x 1200 x 0.8mm	602.8M36.120.048
Brushed Stainless Metalamine 3600x 1200 x 0.8mm	602.8M36.120.058
Brushed Aluminium HMR Particle Board Sheet 3600 x 1200 x 16mm	602.8M36.120.148
Brushed Aluminium HMR Particle Board Rip 3600 x 120 x 16mm	602.8M36.012.048
Brushed Aluminium HMR Particle Board Rip 3600 x 150 x 16mm	602.8M36.015.048

Doors & Panels

Duraform[®] Vinyl Wrapped Doors



Series One

Contemporary soft, plain faced designer, which will enhance a modern kitchen.



Avoca



Bass



Buffalo



Gordon



Gordon 12

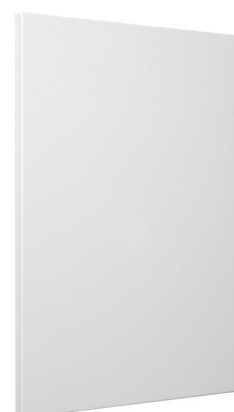

Jamieson



Kiewa

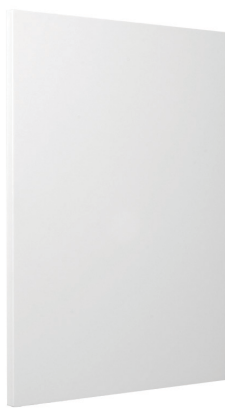

King



Omeo

Doors & Panels

Duraform[®] Vinyl Wrapped Doors



Series Two

Soft round corners and sharp lines for simplicity and functionality in design.



Barwon



Canning



Daly



Emu



Fitzroy



Franklin



Hastings

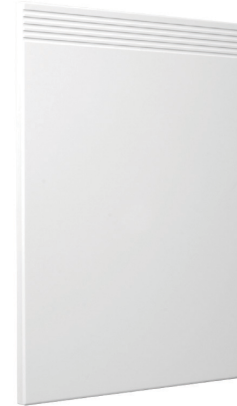

Hunter



Huon



Tambo

Doors & Panels

Duraform® Vinyl Wrapped Doors



Series Three

Square corner routes in most styles and straight defined lines.



Bemm



Catherine



Darling



Derwent



Esk



Goulburn



Jardine



Lachlan



Murray



Swan



Tarwin



Tusmore

Doors & Panels

Duraform® Vinyl Wrapped Doors



Series Four

Classical country styling with contemporary modern lines. V-grooved panels to flat panelled designs.



Acheron



Dargo



Edward



Hay



Howqua



LaTrobe



Loddon



Thompson



Thompson 3



Thompson 5



Thompson SL



Thompson 3SL



Thompson 5SL

Doors & Panels

Duraform[®] Vinyl Wrapped Doors



Series Five

Detailed design. Raised, 3-dimensional bolection moulds, complimented by v-grooved or flat panel plaques.



Aire



Hopkins



Hume Lachlan



Hume Murray



Plenty



Yarra

Doors & Panels

Duraform[®] Vinyl Wrapped Doors

Options & Accessories

Fold Backs and Wrap Around Panels Option

End panels are vinyl wrapped and returned without joins.

Ideal for refrigerator panels, pantry panels, island end panels and decorative pieces for furniture.



18 or 35mm Fold Back
Available in 100, 200, 300, 400 and 500mm returns.
Restricted by sheet size

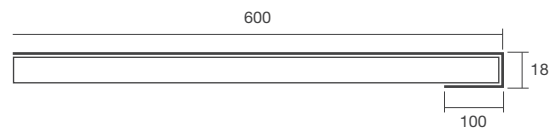

Doors & Panels

Duraform[®] Vinyl Wrapped Doors

Options & Accessories

There is a wide range of options available including: decorative flutes, circular flutes, wine racks, roller shutter frames, open shelves, capping mould and a range of one to eight pane colonial frames.



Column



Flute



Flute with singular rose



Flute with two roses



Decorative trim



Rose

Doors & Panels

Duraform® Vinyl Wrapped Doors

Options & Accessories

Wine Rack Tubes

Available in black, white and stainless steel.

Overall dimension of tube is 310mm front to back with a 90mm diameter hole.



Cap Moulds

Available in two sizes.



Cap Mould



Cap Mould 65

Frames

Frames are available up to 10 panes depending on door size.



Single frame



Colonial Four Pane



Colonial Six Pane



Colonial Eight Pane

Doors & Panels

Duraform[®] Vinyl Wrapped Doors

Door Variations

All Duraform doors come standard as square. However, all door profiles are also available with the following variations:



Shoulder Arch



Round Arch



Arch



Double Arch



Double Bow Arch



Bow Arch

Recess Rails 70 x 25mm

Recess rail dimensions: 70 x 25mm
Available in two profiles, Type C and Type L

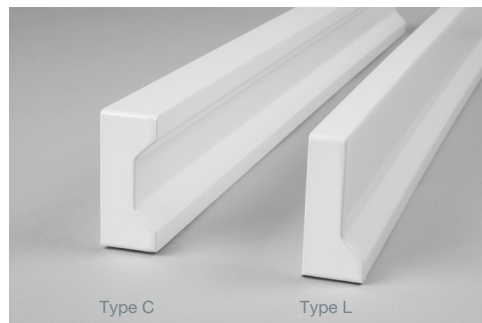

Type C

Type L

Doors & Panels

Duraform® Vinyl Wrapped Doors

Ordering Tools and Resources

Visit titustekform.com.au

- Download the Janper Vinyl Door order forms
- Download the Janper Door & Panel Brochure
- Visit your local Titus Tekform branch to view samples and displays

OFFICE USE ONLY

Job N°: _____
 Invoice N°: _____
 Terms: COD Account Page N° 1 / 2

Customer: _____
Address: _____
Contact: _____
Phone: _____
Fax: _____

Order N°: _____
Date Ordered: _____
Date Required: _____
Job No: _____

Alterations and cancellations must be made within 4 hours of the order being placed. Any alterations and cancellations after this time could incur a charge. All alterations must be in writing quoting the order number.

Door Type: _____

Arched or Square: _____

Door Colour: _____

Edge Detail: 6mm Pencil Round Ogee Stepped Pencil Round 2mm Pencil Round Square
(6mm Pencil Round Standard on Series 2 - 3)

Line No.	Qty	Height (mm)	Width (mm)	K for square edge				Description	Customer Use
				F	B	L	R		
1									
2									
3									
4									
5									
6									
7									
8									
9									
10									
11									
12									
13									
14									
15									
16									
17									
18									
19									
20									
21									
22									
23									
24									
25									
26									
27									
28									
29									
30									

CAPPING MOULD - 2.4m LENGTHS x 38mm HIGH

Sydney Unit 143, 4143 Whylla Place, Prestons, NSW, 2170 02 9628 0007 02 9628 0074 (Fax)	Newcastle Unit 3, 188 Marlburg Road, Cardiff, NSW, 2285 02 4954 4011 02 4954 4233 (Fax)	Melbourne 850 Jersey Road, Bayswater, VIC, 3153 3 9737 5566 3 9729 5760 (Fax) Postal: PO Box 357, Bayswater, VIC, 3153
Tasmania 88 Hopkins St, Moonah, Tas 7509 Phone (03) 6273 1199 Fax (03) 6273 0050	South Australia 8 847 2100 8 847 3163 (Fax) Postal: PO Box 397, Bayswater, VIC, 3153	Wodonga 220 Main Street, Wodonga, VIC, 3690 2 6056 3188 2 6056 3190 (Fax)
Brisbane 122 Northern Place, Virginia, QLD, 4014 07 3266 3959 07 3266 5234 (Fax) Postal: PO Box 266, Northgate, QLD, 4013	Townsville 20 Civil Road, Garbutt, QLD, 4814 07 4779 1366 07 4779 1316 (Fax) Postal: PO Box 7924, Garbutt, QLD, 4815	Northern Territory 122 Northern Place, Virginia, QLD, 4014 07 3266 3959 07 3266 5234 (Fax) Postal: PO Box 266, Northgate, QLD, 4013

Doors & Panels

Alifrost® Aluminium Framed Doors & Drawer Fronts

Product Overview

- Alifrost® is a range of aluminium framed Perspex®, 3D gloss acrylic, glass & Alimesh® doors & panels
- Alifrost® offers a modern look with an exclusive range of European designed frames combined with the latest decorative insert options
- 10 year guarantee applicable on all genuine Perspex® inserts
- Easy maintenance – when supplied with a Perspex® Frost insert, Alifrost® doors have a unique “anti-fingermark” finish reducing the need for cleaning
- When inserted with Perspex® & 3D acrylic gloss Acrylic, Alifrost® doors are ultra hygienic making them ideal for food preparation areas
- Alifrost® doors offer superior impact resistance over glass when used with Perspex® inserts
- Alifrost® doors with Perspex® are lightweight (half that of glass doors), making them easier to use & less stress on hardware components particularly for larger doors
- Environmentally friendly – the two main components of Alifrost® doors, aluminium & Perspex® are fully recyclable



Product Applications

- Kitchens/bathroom doors, drawers & lift up panels
- Vanity mirror cabinet doors – meets Australian Safety standards
- Alfresco kitchens - Perspex® is guaranteed for 10 years for exterior applications
- Entertainment units
- Speaker covers - Alimesh® inserts only
- Wardrobes
- Caravans
- Room dividers

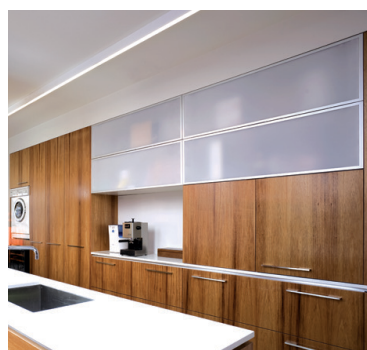

Doors & Panels

Alifrost® Aluminium Framed Doors & Drawer Fronts



Frame Options

19 Square



- Superior clear anodised (CA) finish
- Hollow construction for rigidity
- Suitable for all insert types
- Integrated handle option available
- Recommended for hinge & bi-fold doors, sliding and lift flap doors
- Powder coat colours also available

43 x 55 Flat



- Superior clear anodised (CA) finish
- Hollow construction for rigidity
- Suitable for all insert types
- Integrated handle option available
- Recommended for hinged doors, lift flap and lift up doors, drawers and sliding doors

43 x 55 - Euro Stainless



- Superior Euro Stainless (ES) finish to match the latest Euro appliances
- Hollow construction for rigidity
- Suitable for all insert types
- Recommended for hinged doors, lift flap and lift up doors, drawers and sliding doors

9 x 55 Box



- Superior clear anodised (CA) finish
- Hollow construction for rigidity
- Suitable for all insert types
- Integrated handle option available
- Recommended for hinged doors, lift flap and lift up doors, drawers and sliding doors
- Powder coat colours now available

Doors & Panels

Alifrost® Aluminium Framed Doors & Drawer Fronts



Frame Options

45 x 45 Flat



- Superior clear anodised (CA) finish
- Hollow construction for rigidity
- Suitable for all insert types
- Recommended for hinged doors, lift flap and lift up doors, drawers and sliding door
- Powder coat colours now available

45 x 45 Flat - Brushed Stainless

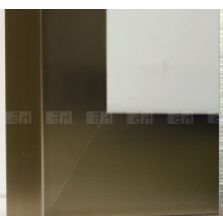

- Superior brushed stainless (BS) finish
- Hollow construction for rigidity
- Suitable for all insert types
- Recommended for hinged doors, lift flap and lift up doors, drawers and sliding doors

6 x 45 Box - Clear Anodised

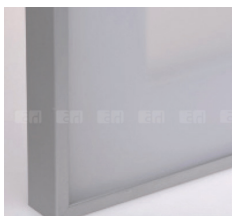

- Superior clear anodised (CA) finish
- Hollow construction for rigidity
- Suitable for all insert types
- Highly recommended for use with glass as a vanity mirror
- Powder coat colours available

6 x 45 Box - Polished Silver



- New polished silver finish with anti scratch ribbed back
- Hollow construction for rigidity
- Suitable for all insert types
- Highly recommended for use with glass as a vanity mirror

Doors & Panels

Alifrost® Aluminium Framed Doors & Drawer Fronts

Frame Options

55 Slimline



- Superior clear anodised (CA) finish
- Hollow construction for rigidity
- Suitable for non-translucent (NT) inserts only
- Integrated handle option available
- Highly recommended for use with 3D acrylic gloss inserts
- Powder coat colours available



AliHandle™



- Superior clear anodised (CA) finish
- New integrated, flush fitted handle option
- Suitable for 19 Square, 43 x 55 Flat CA, 9 x 55
- Box & 55 Slimline
- 50, 100 & 150mm length options

Doors & Panels

Alifrost® Aluminium Framed Doors & Drawer Fronts

Insert Options

Perspex® Ultra High Gloss

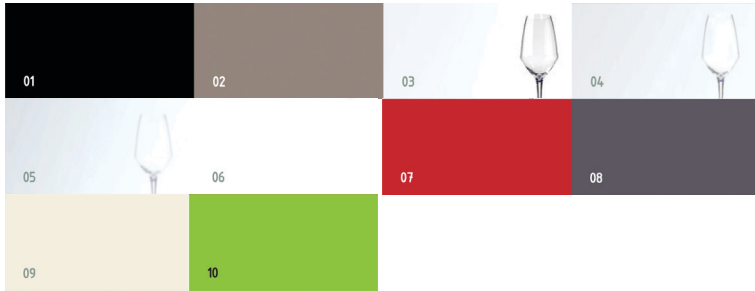

- 01 Black 962
- 02 Café Latte 5263
- 03 Clear 000
- 04 Opal 010 - 70% LT
- 05 Opal 030 - 70% LT
- 06 Opal 069 - 9% LT
- 07 Scarlet Rose 4262
- 08 Shadow Grey 9563
- 09 Vanilla 9638
- 10 Green 6T81

Perspex® Frost – Anti Fingermark Finish

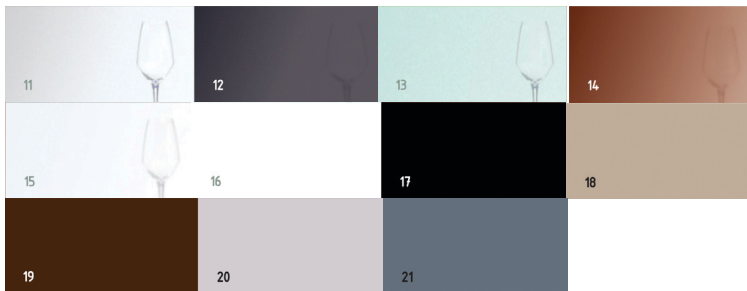

- 11 Crystal Clear S2 000
- 12 Charcoal Grey S2 9T23
- 13 Glacier Green S2 6T21
- 14 Earth Brown S2 5T33
- 15 Polar White S2 030
- 16 Moonlight White S2 1T41
- 17 Midnight Black S2 9221
- 18 Desert Beige S2 5268
- 19 Walnut Brown S2 5269
- 20 Ash Grey S2 9642
- 21 Mineral Grey S2 9643

Perspex® Pearlescent – Metallic Lustre



- 22 Pearl 1PY1
- 23 Platinum 9PY2

Eurmir® - Decorative Acrylic Mirror



- 24 Grey 40

Doors & Panels

Alifrost® Aluminium Framed Doors & Drawer Fronts

Frame Options

Glass



- 25 Clear Glass (toughened)
- 26 Frosted Glass (toughened)
- 27 Glass Safety Mirror

Alimesh® - One Way Vision Aluminium Mesh

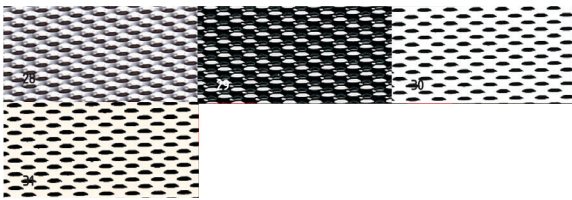

- 28 Clear Anodised 00001
- 29 Black 19268
- 30 White 81880
- 31 White Birch 37131

Alum Composite

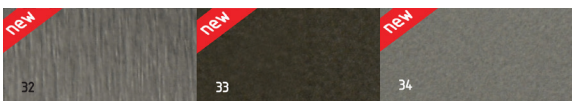

- 32 New Brushed Silver AC32
- 33 New Metallic Charcoal BC44W
- 34 New Metallic Silver BC25

Perspex® Impressions Linear – Textured

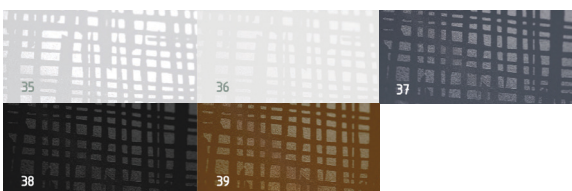

- 35 Clear P1 000
- 36 Opal P1 030
- 37 Grey P1 9T1D
- 38 Black P1 9221
- 39 Brown P1 5T23



= Translucent LT= Light Transmission Level

Doors & Panels

Alifrost® Aluminium Framed Doors & Drawer Fronts

Alifrost® Extras

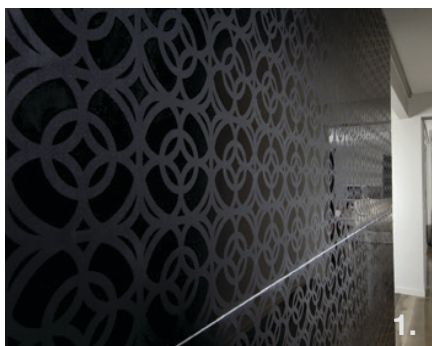

1. Printed patterns available on request (minimum quantities apply)
2. Custom colours and powder coated frames available on request (minimum quantities apply)
3. Multiple inserts with Alirail® - a cross rail for multiple inserts & added rigidity. Suitable for 19 Square, 9 x 55 Box & 43 x 55 Flat frames. Recommended for doors & panels larger than 1.92sqm

Ordering Alifrost® Doors

Visit titustekform.com.au

- Download the Alifrost® door order form
- Download the latest Alifrost® brochure
- Visit your local Titus Tekform branch to view samples & displays

Please fax or email your order to:
 Bk: 157 2086 5234 S.A.: 03 9729 8780 Townsville: 07 4779 1316
 Mtl: 03 9729 8780 Syd: 02 9526 0074 Wodonga: 02 6566 3190
 Newcastle: 02 4954 4233 Tas: 03 6273 0050 Email: info@titustekform.com.au

Titus+ Titustekform

Tekform Branch (Please circle) Page _____ of _____
 Melbourne Brisbane Tasmania Toowoomba Wodonga South Australia
 Sydney Newcastle

Customer: _____ Job: _____
 Address: _____ Office USE ONLY vno
 Phone: _____ Fax: _____ Invoice Number
 Contact: _____ Date Ordered: _____ JAL's Dept Review
 Order Reference: _____ O/N: _____ Box Required YES NO

1 FRAME: CA - Clear Anodised BS - Brushed Stainless PS - Polished Silver
 20 x 20 (CA) 45 x 45 Flat (CA) 6 x 45 Flat (CA) 1 x 55 Box (CA)
 20 x 20 (BS) 45 x 45 Flat (BS) 6 x 45 Flat (BS) 1 x 55 Box (BS)
 20 x 20 (PS) 45 x 45 Flat (PS) 6 x 45 Flat (PS) 1 x 55 Box (PS)
 Only available with NT inserts

Z.INSERT: T = Translucent NT = Non Translucent

PERFEX - Glass <input type="checkbox"/> Black 902 (NT) <input type="checkbox"/> Clear Lute 5200 (NT) <input type="checkbox"/> Clear 000 (F) <input type="checkbox"/> Clear 010 (F) <input type="checkbox"/> Clear 030 (F) <input type="checkbox"/> Clear 019 (NT) <input type="checkbox"/> Crystal Glass 4202 (NT) <input type="checkbox"/> Shadow Grey 9503 (NT) <input type="checkbox"/> Vanilla 9508 (NT) <input type="checkbox"/> Green 4781 (NT)	PERFEX - Frost <input type="checkbox"/> Crystal Clear 5200 (F) <input type="checkbox"/> Clear Glass 5202 (F) <input type="checkbox"/> Glacier Green 5207 (F) <input type="checkbox"/> Earth Stone 5207 (F) <input type="checkbox"/> Polar White 5205 (F) <input type="checkbox"/> Moonlight White 5211 (NT) <input type="checkbox"/> Island Glass 52 5221 (NT) <input type="checkbox"/> Desert Beige 52 5268 (NT) <input type="checkbox"/> Island Stone 52 5269 (NT) <input type="checkbox"/> Ash Grey 52 5662 (NT) <input type="checkbox"/> Mineral Grey 52 5645 (NT)	PERFEX - Impressions <input type="checkbox"/> Clear P1 000 Linear (F) <input type="checkbox"/> Oak P1 020 Linear (F) <input type="checkbox"/> Grey P1 070 Linear (F) <input type="checkbox"/> Iron P1 102 Linear (F) <input type="checkbox"/> Black P1 021 Linear (NT) <input type="checkbox"/> Frost 1P11 (NT) <input type="checkbox"/> Platinum SPV2 (NT)	EUROWN <input type="checkbox"/> Grey 40 (NT) <input type="checkbox"/> GLASS <input type="checkbox"/> Clear Glass (F) <input type="checkbox"/> Frosted Glass (F) <input type="checkbox"/> Glass Safety Mirror (NT) <input type="checkbox"/> Frost 1P11 (NT) <input type="checkbox"/> Pattern SPV2 (NT)	ALMESH <input type="checkbox"/> Clear Anodised 0001 (F) <input type="checkbox"/> Black 1000 (F) <input type="checkbox"/> White 8180 (F) <input type="checkbox"/> White Beak 37131 (F) <input type="checkbox"/> 20 GL-005 (Anodised) <input type="checkbox"/> Anod 30 (NT) <input type="checkbox"/> Brushed Silver 4022 (NT) <input type="checkbox"/> Metallic Charcoal 50046 (NT) <input type="checkbox"/> Metallic Silver 50225 (NT) OTHER
--	--	---	---	---

3 Select Your Door or Panel - 150° Full overlay hinge supplied with 20x20 frame. 110° Full overlay hinge supplied 45mm frame.
 Hinged* (includes hinges, hinges & mounting plates) Panel Only Other

4 Door Size - Hinge positions are 100mm from the top & bottom to centre, other hinges equally spaced from the centre.

Qty	Height	Width	Special Comments	Left or Right Hinge
1	X	X		
2	X	X		
3	X	X		
4	X	X		
5	X	X		
6	X	X		
7	X	X		
8	X	X		

Not to be copied or published without permission.

Doors & Panels

Belle Roller Doors

Product Overview

- Belle roller doors are ideal for all storage requirements
- The door glides open & unlike hinged or bi-fold doors, the entire space in front of the door can be used
- Ideal for concealing kitchen appliances when not in use with the closed door providing an elegant, streamline look
- Available in laminate, vinyl, timber & MDF
- Doors can be manufactured in any size up to 2 metres x 2 metres
- Doors can be fitted with locks, providing extra security in commercial & home office applications
- A remote controlled electric motor can be fitted



Product Specifications

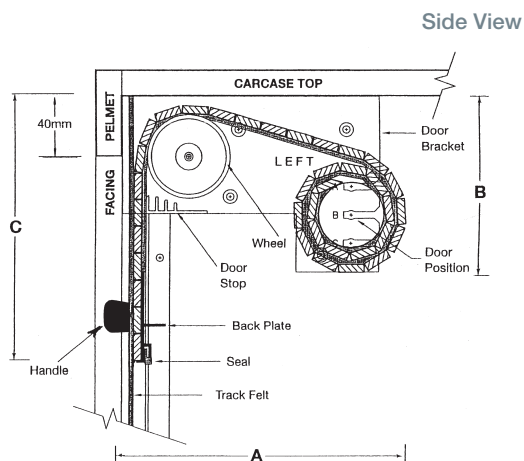

Note:

- 1) Dimension C equals 100mm when the door is fully opened
- 2) Add 50mm to DIMENSION A for making installation easier

Height (mm)	A	B
To 600	190	110
601-900	200	130
901-1200	210	140
1201-1500	215	155
1501-1800	220	170
1801-2100	225	180

Doors & Panels

Belle Roller Doors

Product Specifications

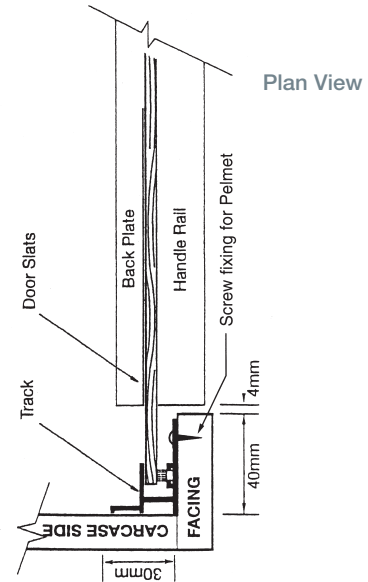
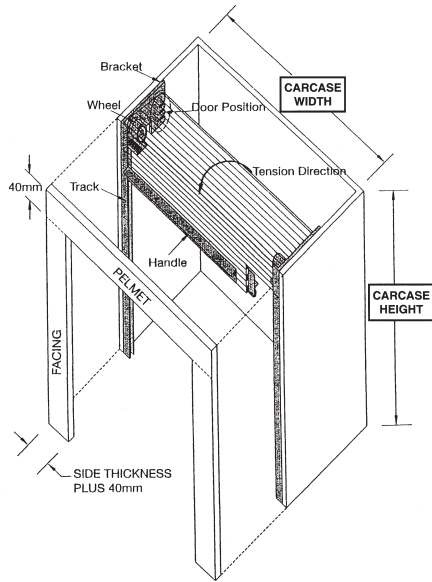

Ordering Belle Roller Doors

Visit titustekform.com.au

Download the Belle Roller Door order forms.

BELLE ROLLER DOOR ORDER FORM	
COMPANY NAME	NAME
ORDER NUMBER	ORDERED BY
BELLE	
INTERNAL CARCASE MEASUREMENTS	
CITY	STREET
ROAD	POSTCODE
STATE	
MATERIAL DESCRIPTION	
MDP	SUBSTRATE
COLOUR	NUMBER
TYPE	BRAND
OTHER	FINISH
DISPLAY DOOR	SUPPLIED MATERIAL
MESSAGE - SHOWROOM ADDRESS	
DELIVERY ADDRESS	
STATE	
POSTCODE	
Titus Tekform Pty Ltd	
Sydney Unit 1&2, 41-43 Whyalla Place, Prestons, NSW, 2170 Ph: 02 9626 0077 Fax: 02 9626 0074	
Newcastle Unit 3, 100 Munbung Road, Cardiff, NSW, 2285 Ph: 02 4954 4011 Fax: 02 4954 4233	
Melbourne 859 Jersey Road, Bayswater, 3153 Ph: 03 9737 5966 Fax: 03 9729 8780	
Wodonga 2201 Main Street, Wodonga, VIC, 3689 Ph: 02 5096 1198 Fax: 02 5096 1190	
SA PO Box 367, Baywater, VIC, 3153 Ph: 08 8447 3700 Fax: 08 8447 3183	
Tasmania 88 Hopkins Street, Moonah, TAS, 7009 Ph: 03 6273 1199 Fax: 03 6273 0030	
Brisbane 132 Northlink Place, Virginia, QLD, 4014 Ph: 07 3266 3999 Fax: 07 3266 5234	
Townsville 20 Civil Road, Garbutt, QLD, 4814 Ph: 07 4776 1386 Fax: 4776 1316	