



# Cabinet Handles

# Cabinet Handles

## Product Guide















### Stefano Orlati Handles















	Page
Information	8.3
Bow Handles	8.4
Profile Handles	8.15
Provincial Handles	8.23
Recessed Handles	8.26
Square Handles	8.27
Stainless Steel Handles	8.43
Knobs	8.45

# Stefano Orlati Handles

## Information

### Colour Finish Guide

AB		Antique Bronze
ABS		Aluminium Brushed Satin
AC		Antique Copper
AI		Antique Iron
BLKN		Black Nickel
BN		Brushed Nickel
BSAT		Brushed Satin Antique Tin
BSBN		Brushed Satin Black Nickel
CH		Chrome
CL		Clear Glass
FS		Foggy Silver
G		Gold
MB		Matt Black
MBN		Matt Brushed Nickel

MC		Matt Chrome
MW		Matt White
P		Pewter
PB		Polished Brass
PCO		Polished Copper*
S		Silver
SB		Satin Brass
SC		Satin Chrome
SN		Satin Nickel
SS		Stainless Steel
T		Tungsten
TG		Titanium Grey
WH		White
WHC		White Crackled Finish

### Guide to Handle Dimensions

**Length:** Overall length of the handle (mm)

**Centre:** Screw hole to screw hole (mm)

**Height:** Height/Projection of handle (mm)

**Width:** Width of handle face (mm)

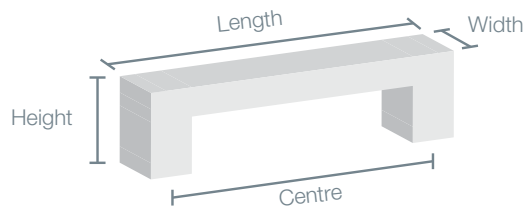



# Stefano Orlati Handles

## Bow Handles

	Centre (mm)	Length (mm)	Height (mm)	Width (mm)	Item number	Finish
<b>122</b>	160	180	26	18	SO-122-160 →	BN
	160	180	26	18	SO-122-160 →	MC
<b>410</b>	96	112	28	10	608.8J20.096.004	MB
	96	112	28	10	608.8J20.096.013	MC
	128	144	35	10	608.8J20.128.013	MC
	96	112	28	10	608.8J20.096.003	BN
	128	144	35	10	608.8J20.128.003	BN
	224	288	37	10	608.8J20.224.003	BN
	96	112	28	10	608.8J20.096.007	CH
	128	144	35	10	608.8J20.096.007	CH
	224	288	37	10	608.8J20.224.007	CH
	96	112	28	10	608.8J20.096.008	SC
	128	144	35	10	608.8J20.128.008	SC
	224	288	37	10	608.8J20.224.008	SC
	96	112	28	10	608.8J20.096.012	BLKN
	128	144	35	10	608.8J20.128.012	BLKN
	224	288	37	10	608.8J20.224.012	BLKN



# Stefano Orlati Handles

## Bow Handles

	Centre (mm)	Length (mm)	Height (mm)	Width (mm)	Item number	Finish
<b>616</b> 	96	114	23	17	<a href="#">SO-616-96-MB &gt;</a>	MB
	128	150	27	21	<a href="#">SO-616-128-MB &gt;</a>	MB
	192	226	31	23	<a href="#">SO-616-128-MB &gt;</a>	MB
	96	114	23	17	<a href="#">SO-616-96-TG →</a>	TG
	128	150	27	21	<a href="#">SO-616-128-TG →</a>	TG
	192	226	31	23	<a href="#">SO-616-192-TG →</a>	TG
<b>684</b> 	K	32	25	32	<a href="#">SO-684-K-CMB →</a>	CMB
	96	119	25	21	<a href="#">SO-684-96-CMB →</a>	CMB
	128	151	25	23	<a href="#">SO-684-128-CMB →</a>	CMB

# Stefano Orlati Handles

## Bow Handles

	Centre (mm)	Length (mm)	Height (mm)	Width (mm)	Item number	Finish
<b>782</b>  	96	115	28	10	608.8F21.096.007	PC
	96	115	28	10	608.8F21.096.008	SC
	128	148	28	10	608.8F21.128.007	PC
	128	148	28	10	608.8F21.128.008	SC
<b>1037</b>  	128	158	29	10	SO-1037-128 >	BN
	128	158	29	10	SO-1037-128 >	MC
	128	158	29	10	SO-1037-128 >	CH
	128	158	29	10	SO-1037-128 >	PB
	128	158	29	10	SO-1037-128 >	SB

# Stefano Orlati Handles



## Bow Handles

	Centre (mm)	Length (mm)	Height (mm)	Width (mm)	Item number	Finish
<b>2060</b> 	96	115	28	10	<a href="#">SO-2060-96</a> →	BN
	128	154	30	10	<a href="#">SO-2060-128</a> →	BN
	96	115	28	10	<a href="#">SO-2060-96</a> →	MC
	128	154	30	10	<a href="#">SO-2060-128</a> →	MC
<b>3130</b> 	128	147	30	18	<a href="#">SO-3130-128</a> →	BN
	192	212	30	18	<a href="#">SO-3130-192</a> →	BN
	256	275	30	18	<a href="#">SO-3130-256</a> →	BN
	416	430	30	18	<a href="#">SO-3130-416</a> →	BN
	128	147	30	18	<a href="#">SO-3130-128</a> →	MB
	192	212	30	18	<a href="#">SO-3130-192</a> →	MB
	256	275	30	18	<a href="#">SO-3130-256</a> →	MB
	416	430	30	18	<a href="#">SO-3130-416</a> →	MB
	128	147	30	18	<a href="#">SO-3130-128</a> →	WH
	192	212	30	18	<a href="#">SO-3130-192</a> →	WH
	256	275	30	18	<a href="#">SO-3130-256</a> →	WH
	416	430	30	18	<a href="#">SO-3130-416</a> →	WH



# Stefano Orlati Handles

## Bow Handles

	Centre (mm)	Length (mm)	Height (mm)	Width (mm)	Item number	Finish
<b>3319</b> 	96	140	22	15	<a href="#">SO-3319-96</a> →	BN
	192	250	22	15	<a href="#">SO-3319-192</a> →	BN
	96	140	22	15	<a href="#">SO-3319-96</a> →	MC
	192	250	22	15	<a href="#">SO-3319-192</a> →	MC
<b>3380</b> 	128	151	28	25	<a href="#">SO-3380-128</a> →	BN
	160	189	28	25	<a href="#">SO-3380-160</a> →	BN
	224	260	33	25	<a href="#">SO-3380-224</a> →	BN
	320	358	33	25	<a href="#">SO-3380-320</a> →	BN
	128	151	28	25	<a href="#">SO-3380-128</a> →	T
	160	189	25	25	<a href="#">SO-3380-160</a> →	T
	224	260	33	25	<a href="#">SO-3380-224</a> →	T
	320	358	33	25	<a href="#">SO-3380-320</a> →	T

# Stefano Orlati Handles

## Bow Handles

	Centre (mm)	Length (mm)	Height (mm)	Width (mm)	Item number	Finish
<b>6329</b> 	128	167	26	22	<a href="#">SO-6329-128</a> →	CH
	192	231	26	22	<a href="#">SO-6329-192</a> →	CH
	128	167	26	22	<a href="#">SO-6329-128</a> →	MB
	192	231	26	22	<a href="#">SO-6329-192</a> →	MB
	256	295	26	22	<a href="#">SO-6329-256</a> →	MB
	320	359	27	22	<a href="#">SO-6329-320</a> →	MB
	128	167	26	22	<a href="#">SO-6329-128</a> →	MBN
	192	231	26	22	<a href="#">SO-6329-192</a> →	MBN
	256	295	26	22	<a href="#">SO-6329-256</a> →	MBN
	320	359	27	22	<a href="#">SO-6329-320</a> →	MBN
<b>7025</b> 	128	138	25	20	<a href="#">SO-7025-128</a> →	BN
	160	170	28	20	<a href="#">SO-7025-160</a> →	BN
	224	234	28	20	<a href="#">SO-7025-224</a> →	BN
	320	330	28	20	<a href="#">SO-7025-320</a> →	BN
	128	138	25	20	<a href="#">SO-7025-128</a> →	MC
	160	170	28	20	<a href="#">SO-7025-160</a> →	MC
	224	234	28	20	<a href="#">SO-7025-224</a> →	MC
	320	330	28	20	<a href="#">SO-7025-320</a> →	MC
<b>7039</b> 	128	160	25	22	<a href="#">608.8H20.128.003</a>	BN
	160	190	25	22	<a href="#">608.8H20.160.003</a>	BN
	256	286	25	22	<a href="#">608.8H20.256.003</a>	BN
	320	350	25	22	<a href="#">608.8H20.320.003</a>	BN





# Stefano Orlati Handles

## Bow Handles

	Centre (mm)	Length (mm)	Height (mm)	Width (mm)	Item number	Finish
<b>7090</b> 	96	138	36	16	608.8F17.096.003	BN
	128	168	36	16	608.8F17.128.003	BN
	160	200	36	16	608.8F17.160.003	BN
	256	296	36	16	608.8F17.256.003	BN
	320	360	36	16	608.8F17.320.003	BN
<b>7127</b> 	128	148	29	10	608.8F16.128.003	BN
	160	180	29	10	608.8F16.160.003	BN
	256	276	29	10	608.8F16.256.003	BN
	320	344	29	10	608.8F16.320.003	BN
<b>7165</b> 	96	136	25	25	608.8H18.096.003	BN
	128	168	25	25	608.8H18.128.003	BN
	160	200	25	25	608.8H18.160.003	BN
	256	296	25	25	608.8H18.256.003	BN
<b>7179</b> 	96	124	24	19	608.8F18.096.003	BN
	128	157	27	19	608.8F18.128.003	BN
	160	189	28	19	608.8F18.160.003	BN
	256	286	30	19	608.8F18.256.003	BN

# Stefano Orlati Handles

## Bow Handles

	Centre (mm)	Length (mm)	Height (mm)	Width (mm)	Item number	Finish
<b>7229</b> 	128	170	32	12	608.8H21.128.003	BN
	160	202	34	12	608.8H21.160.003	BN
	320	362	32	12	608.8H21.320.003	BN
<b>7232</b> 	128	165	28	12	608.8H19.128.003	BN
	160	197	29	12	608.8H19.160.003	BN
	320	344	32	12	608.8H19.320.003	BN
<b>7235</b> 	128	163	27	16	608.8O19.128.003	BN
	160	204	26	16	608.8O19.160.003	BN
	320	372	26	16	608.8O19.320.003	BN
<b>7236</b> 	128	214	25	16	608.8O20.128.003	BN
	160	268	26	16	608.8O20.160.003	BN
	320	404	25	16	608.8O20.320.003	BN

# Stefano Orlati Handles

## Bow Handles

7530



Centre (mm)	Length (mm)	Height (mm)	Width (mm)	Item number	Finish
16	42	24	28	<a href="#">SO-7530-16-MB</a> →	MB
64	100	24	30	<a href="#">SO-7530-64-MB</a> →	MB
96	132	24	20	<a href="#">SO-7530-96-MB</a> →	MB
128	164	24	20	<a href="#">SO-7530-128-MB</a> →	MB
224	268	24	20	<a href="#">SO-7530-224-MB</a> →	MB
16	42	24	28	<a href="#">SO-7530-16-TG</a> →	TG
64	100	24	30	<a href="#">SO-7530-64-TG</a> →	TG
96	132	24	20	<a href="#">SO-7530-96-TG</a> →	TG
128	164	24	20	<a href="#">SO-7530-128-TG</a> →	TG
224	268	24	20	<a href="#">SO-7530-224-TG</a> →	TG



# Stefano Orlati Handles

## Bow Handles

	Centre (mm)	Length (mm)	Height (mm)	Width (mm)	Item number	Finish
<b>9718</b> 	96	141	30	9	<a href="#">SO-9718-96</a> →	BN
	128	200	30	12	<a href="#">SO-9718-128</a> →	BN
	96	141	30	9	<a href="#">SO-9718-96</a> →	MC
	128	200	30	12	<a href="#">SO-9718-128</a> →	MC
<b>9908</b> 	96	105	30	13	<a href="#">SO-9908-96</a> →	BN
	128	147	30	14	<a href="#">SO-9908-128</a> →	BN
	96	105	30	13	<a href="#">SO-9908-96</a> →	CH
	128	147	30	14	<a href="#">SO-9908-128</a> →	CH
	96	105	30	13	<a href="#">SO-9908-96</a> →	MC
	128	147	30	14	<a href="#">SO-9908-128</a> →	MC
<b>9910</b> 	96	114	21	10	<a href="#">SO-9910-96</a> →	BN
	128	150	27	12	<a href="#">SO-9910-128</a> →	BN
	96	114	21	10	<a href="#">SO-9910-96</a> →	MC
	128	150	27	12	<a href="#">SO-9910-128</a> →	MC

# Stefano Orlati Handles

## Bow Handles

	Centre (mm)	Length (mm)	Height (mm)	Width (mm)	Item number	Finish
<b>ARC</b> 	128	153	31	10	SO-ARC-128 →	BN
	160	190	31	10	SO-ARC-160 →	BN
	224	263	31	10	SO-ARC-224 →	BN
	288	336	31	10	SO-ARC-288 →	BN
<b>C</b> 	128	148	26	10	SO-C-128 →	BN
	160	180	26	10	SO-C-160 →	BN
	192	212	26	10	SO-C-192 →	BN
	128	148	26	10	SO-C-128 →	FS
	160	180	26	10	SO-C-160 →	FS
	192	212	26	10	SO-C-192 →	FS
	128	148	26	10	SO-C-128 →	MB
	160	180	26	10	SO-C-160 →	MB
	192	212	26	10	SO-C-192 →	MB
<b>TSB</b> 	96	111	29	10	SO-TSB-96 →	MB
	96	111	29	10	SO-TSB-96 →	BLKN
	128	150	30	10	SO-TSB-128 →	BLKN
	96	111	29	10	SO-TSB-96 →	BN
	128	150	30	10	SO-TSB-128 →	BN
	96	111	29	10	SO-TSB-96 →	CH
	128	150	30	10	SO-TSB-128 →	CH
	96	111	29	10	SO-TSB-96 →	MC
	128	150	30	10	SO-TSB-128 →	MC
	96	111	29	10	SO-TSB-96 →	SN
	128	150	30	10	SO-TSB-128 →	SN

# Stefano Orlati Handles

## Profile Handles

- Create handleless openings for doors and top drawers
- Horizontal mounting
- Available in six on-trend finishes

	Length (mm)	Height (mm)	Depth (mm)	Item number	Finish
<b>CAPRI-J</b>	3600	57.1	26	608.8U10.360.001	FS
	3600	57.1	26	608.8U10.360.007	CH
	3600	57.1	26	608.8U10.360.010	MB
	3600	57.1	26	608.8U10.360.011	MW
	3600	57.1	26	608.8U10.360.013	TG
	3000	57.1	26	608.8U10.360.015	G

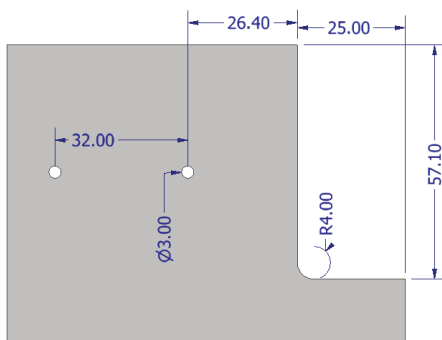

· End caps and brackets ordered separately

*Quoted dimensions consider that the CAPRI profile will have a 1mm overhang. Increase measurements by 1mm for applications where the CAPRI profile should be flush with the cabinet sides.*



# Stefano Orlati Handles

## Profile Handles

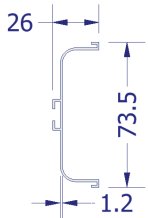
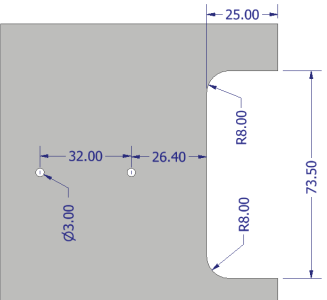
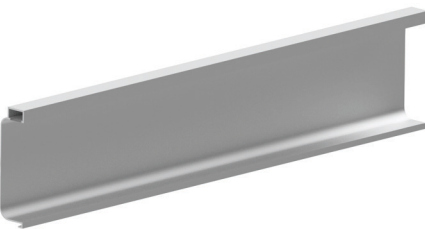
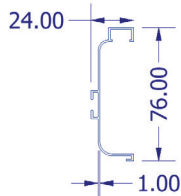
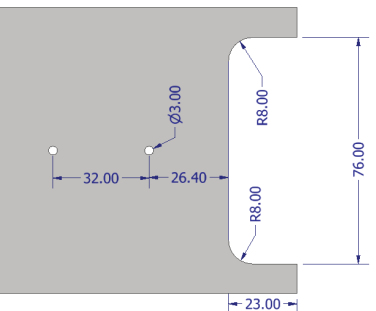

- Create handleless openings for drawers
- Horizontal mounting

	Length (mm)	Height (mm)	Depth (mm)	Item number	Finish
<b>CAPRI-C</b>   	3600	73.5	26	<b>608.8U08.360.001</b>	FS
	3600	73.5	26	<b>608.8U08.360.007</b>	CH
	3600	73.5	26	<b>608.8U08.360.010</b>	MB
	3600	73.5	26	<b>608.8U08.360.011</b>	MW
	3600	73.5	26	<b>608.8U08.360.013</b>	TG
	3000	73.5	26	<b>608.8U08.360.015</b>	G
	<ul style="list-style-type: none"> <li>· Available in six on-trend finishes</li> <li>· End caps and brackets ordered separately</li> </ul> <p><i>Quoted dimensions consider that the CAPRI profile will have a 1mm overhang. Increase measurements by 1mm for applications where the CAPRI profile should be flush with the cabinet sides.</i></p>				
<b>CAPRI-C LED</b>   	3600	76	24	<b>608.8U09.360.001</b>	FS
	3600	76	24	<b>608.8U09.360.007</b>	CH
	3600	76	24	<b>608.8U09.360.010</b>	MB
	3600	76	24	<b>608.8U09.360.011</b>	MW
	3600	76	24	<b>608.8U09.360.013</b>	TG
	3000	76	24	<b>608.8U09.360.015</b>	G
	<ul style="list-style-type: none"> <li>· Integrated LED profile &amp; strip</li> </ul> <p><i>Quoted dimensions consider that the CAPRI profile will have a 1mm overhang. Increase measurements by 1mm for applications where the CAPRI profile should be flush with the cabinet sides.</i></p>				

# Stefano Orlati Handles

## Profile Handles

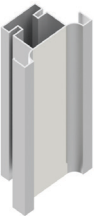
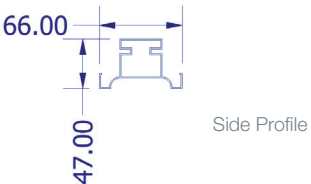
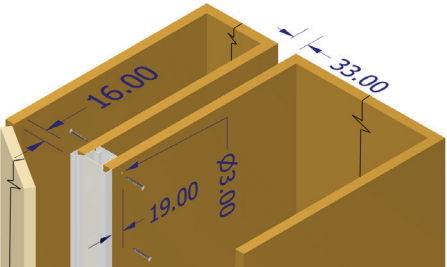
· Available in six on-trend finishes

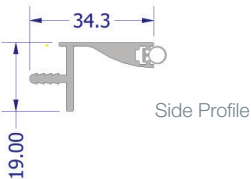
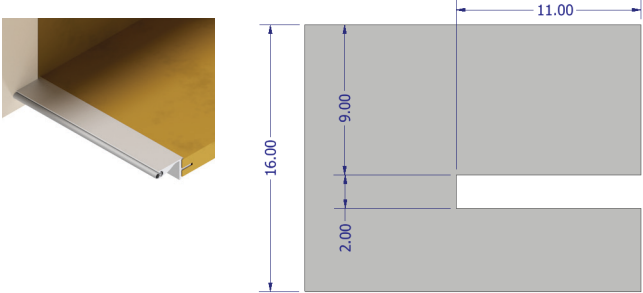
	Length (mm)	Height (mm)	Depth (mm)	Item number	Finish
<b>CAPRI-Y</b>   <p>Side Profile</p> 	2400	66	47	<b>608.8U16.360.001</b>	FS
	2400	66	47	<b>608.8U16.360.007</b>	CH
	2400	66	47	<b>608.8U16.360.010</b>	MB
	2400	66	47	<b>608.8U16.360.011</b>	MW
	2400	66	47	<b>608.8U16.360.013</b>	TG
	2400	66	47	<b>608.8U16.360.015</b>	G
	<ul style="list-style-type: none"> <li>· Create handleless openings for tower cabinets</li> <li>· Vertical mounting between cabinets</li> </ul>				
<b>CAPRI-R</b>   <p>Side Profile</p> 	3600	19	34.3	<b>608.8U14.360.001</b>	FS
	3600	19	34.3	<b>608.8U14.360.007</b>	CH
	3600	19	34.3	<b>608.8U14.360.010</b>	MB
	3600	19	34.3	<b>608.8U14.360.011</b>	MW
	3600	19	34.3	<b>608.8U14.360.013</b>	TG
	3000	19	34.3	<b>608.8U14.360.015</b>	G
	<ul style="list-style-type: none"> <li>· Create handleless openings for wall cabinets</li> <li>· Horizontal mounting</li> </ul> <p><i>Note: Can be used on 16mm and 18mm board. Dimensions are still 9mm from top to top of cutout</i></p>				

# Stefano Orlati Handles

## Profile Handles

### CAPRI-N

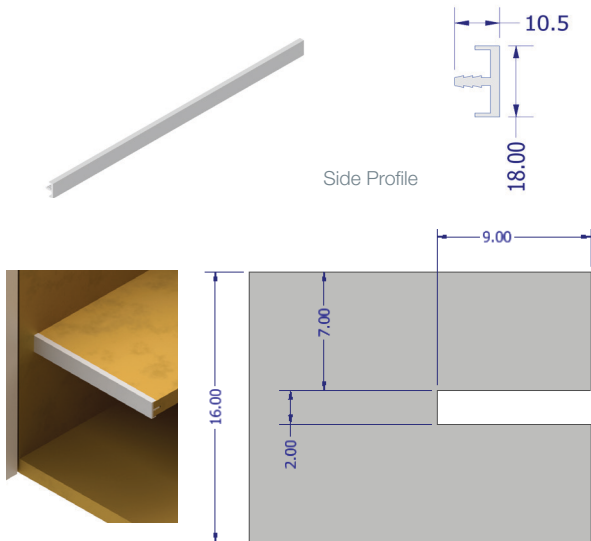

Handing	Length (mm)	Height (mm)	Depth (mm)	Item number	Finish
	3600	18	10.5	608.8U12.360.001	FS
	3600	18	10.5	608.8U12.360.007	CH
	3600	18	10.5	608.8U12.360.010	MB
	3600	18	10.5	608.8U12.360.011	MW
	3600	18	10.5	608.8U12.360.013	TG
	3000	18	10.5	608.8U12.360.015	G

- Shelf edge protection
- Horizontal mounting
- Available in six on-trend finishes

*Note: N Profile only suits 16mm board*

### CAPRI Profile Mounting Bracket

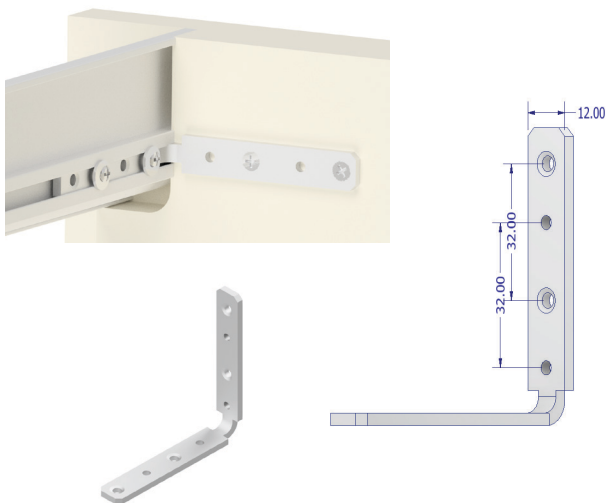

Universal				608.8U19.070.001	
-----------	--	--	--	------------------	--

- Universal mounting bracket for CAPRI Profile range
- Simple 3 step mounting process

# Stefano Orlati Handles

## Profile Handles

### CAPRI-J End Caps

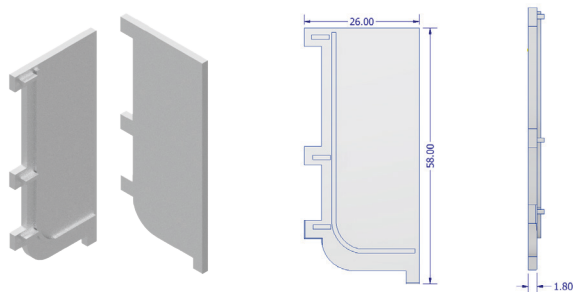

Handing	Item number	Finish
Left	608.8U17.056.001	FS
Right	608.8U17.057.001	FS
Left	608.8U17.056.007	CH
Right	608.8U17.057.007	CH
Left	608.8U17.056.010	MB
Right	608.8U17.057.010	MB
Left	608.8U17.056.011	MW
Right	608.8U17.057.011	MW
Left	608.8U17.056.013	TG
Right	608.8U17.057.013	TG
Left	608.8U17.056.015	G
Right	608.8U17.057.015	G

### CAPRI-C End Caps

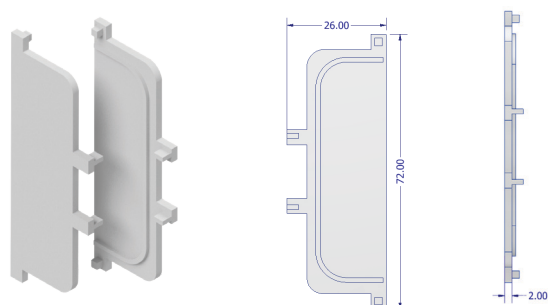

Universal	608.8U17.073.001	FS
Universal	608.8U17.073.007	CH
Universal	608.8U17.073.010	MB
Universal	608.8U17.073.011	MW
Universal	608.8U17.073.013	TG
Universal	608.8U17.073.015	G

# Stefano Orlati Handles

## Profile Handles

**548**



Centre (mm)	Length (mm)	Height (mm)	Width (mm)	Item number	Finish
128	170	26	17	<a href="#">SO-548-128</a> →	ABS
192	235	26	17	<a href="#">SO-548-192</a> →	ABS
320	362	26	17	<a href="#">SO-548-320</a> →	ABS
544	588	26	17	<a href="#">SO-548-544</a> →	ABS
608	650	26	17	<a href="#">SO-548-608</a> →	ABS
736	775	26	17	<a href="#">SO-548-736</a> →	ABS
128	170	26	17	<a href="#">SO-548-128</a> →	MB
192	235	26	17	<a href="#">SO-548-192</a> →	MB
320	362	26	17	<a href="#">SO-548-320</a> →	MB
544	588	26	17	<a href="#">SO-548-544</a> →	MB
608	650	26	17	<a href="#">SO-548-608</a> →	MB
775	736	26	26	<a href="#">SO-548-736-MB</a> →	MB

# Stefano Orlati Handles

## Profile Handles

	Centre (mm)	Length (mm)	Height (mm)	Width (mm)	Item number	Finish	
<b>2163</b>	25	40	18	45	SO-2163-40-MB →	MB	
		200	18	45	SO-2163-200-BA →	BA	
		200	18	45	SO-2163-200-BC →	BC	
		200	18	45	SO-2163-200-BN →	BN	
		200	18	45	SO-2163-200-MB →	MB	
		200	18	45	SO-2163-200-SB →	SB	
		300	18	45	SO-2163-300-BA →	BA	
		300	18	45	SO-2163-300-BC →	BC	
		300	18	45	SO-2163-300-BN →	BN	
		300	18	45	SO-2163-300-MB →	MB	
		300	18	45	SO-2163-300-SB →	SB	
		350	18	45	SO-2163-350-BA →	BA	
		350	18	45	SO-2163-350-BC →	BC	
		350	18	45	SO-2163-350-MB →	MB	
		350	18	45	SO-2163-350-SB →	SB	
		25	40	18	45	SO-2163-40-BA →	BA
		25	40	18	45	SO-2163-40-BC →	BC
		25	40	18	45	SO-2163-40-BN →	BN
		25	40	18	45	SO-2163-40-SB →	SB





# Stefano Orlati Handles

## Profile Handles

	Centre (mm)	Length (mm)	Height (mm)	Width (mm)	Item number	Finish	
<b>7130</b> 	20	40	25	35	<b>608.8C17.020.010</b>	MB	
	80	100	25	35	<b>608.8C17.080.010</b>	MB	
	160	180	25	35	<b>608.8C17.160.010</b>	MB	
	260	280	25	35	<b>608.8C17.260.010</b>	MB	
	20	40	25	35	<b>608.8C17.020.003</b>	BN	
	80	100	25	35	<b>608.8C17.080.003</b>	BN	
	160	180	25	35	<b>608.8C17.160.003</b>	BN	
	260	280	25	35	<b>608.8C17.260.003</b>	BN	
	<b>R156</b> 	64	90	17	41	<b>SO-R156-64</b> →	ABS
		160	190	17	41	<b>SO-R156-160</b> →	ABS
64		90	17	41	<b>SO-R156-64</b> →	FS	
160		190	17	41	<b>SO-R156-160</b> →	FS	
· Mounts on top of panel edge							
<b>PESARO PULL</b> 	200	18	36		<b>SO-PP-200</b> →	ABS	
	2 screw holes - 40mm from edge						
	400	18	36		<b>SO-PP-400</b> →	ABS	
	3 screw holes - 100mm between each hole & edge						
	600	18	36		<b>SO-PP-600</b> →	ABS	
	4 screw holes - 120mm between each hole & edge						
	1250	18	36		<b>SO-PP-1250</b> →	ABS	
Without holes drilled							
· Mounts on top of panel edge							

# Stefano Orlati Handles





## Provincial Handles

	Centre (mm)	Length (mm)	Height (mm)	Width (mm)	Item number	Finish
<b>1186</b> 	96	132	29	14	<a href="#">SO-1186-96</a> →	BSAT
	160	204	29	16	<a href="#">SO-1186-160</a> →	BSAT
	96	132	29	14	<a href="#">SO-1186-96</a> →	BSBN
	160	204	29	16	<a href="#">SO-1186-160</a> →	BSBN
	Complimentary knob 1186K page → 8.46					
<b>1208</b> 	96	135	31	34	<a href="#">SO-1208-96</a> →	BSAT
	96	135	31	34	<a href="#">SO-1208-96</a> →	BSBN
	Complimentary knob 1186K page → 8.46					
<b>3440</b> 	128	150	33	18	<a href="#">SO-3440-128</a> →	AC
	160	182	33	18	<a href="#">SO-3440-160</a> →	AC
	224	246	33	18	<a href="#">SO-3440-224</a> →	AC
	320	342	33	18	<a href="#">SO-3440-320</a> →	AC
	128	150	33	18	<a href="#">SO-3440-128</a> →	BN
	160	182	33	18	<a href="#">SO-3440-160</a> →	BN
	224	246	33	18	<a href="#">SO-3440-224</a> →	BN
	320	342	33	18	<a href="#">SO-3440-320</a> →	BN
	128	150	33	18	<a href="#">SO-3440-128</a> →	BSBN
	160	182	33	18	<a href="#">SO-3440-160</a> →	BSBN
	224	246	33	18	<a href="#">SO-3440-224</a> →	BSBN
	320	342	33	18	<a href="#">SO-3440-320</a> →	BSBN
	Complimentary knob 3440K page → 8.47					



# Stefano Orlati Handles

## Provincial Handles

	Centre (mm)	Length (mm)	Height (mm)	Width (mm)	Item number	Finish
<b>8391</b> 	160	180	32	40	<b>SO-8391-160</b> →	P
	Complementary knob 3801 page → 8.48 Complementary knob 8393 page → 8.49					
<b>8392</b> 	128	188	28	21	<b>SO-8392-128</b> →	P
	Complementary knob 3801 page → 8.48 Complementary knob 8393 page → 8.49					
<b>8407</b> 	64	90	23	34	<b>SO-8407-64</b> →	AB
	64	90	23	34	<b>SO-8407-64</b> →	BN
	64	90	23	34	<b>SO-8407-64</b> →	CH
	Complementary knob 8741 page → 8.49					
<b>8658</b> 	96	132	25	16	<b>SO-8658-96</b> →	AB
	96	132	25	16	<b>SO-8658-96</b> →	BN
	96	132	25	16	<b>SO-8658-96</b> →	CH
	Complementary knob 8741 page → 8.49					

# Stefano Orlati Handles

## Provincial Handles

**C15**



Centre (mm)	Length (mm)	Height (mm)	Width (mm)	Item number	Finish
-------------	-------------	-------------	------------	-------------	--------

128	150	40	23	<b>SO-C15-128</b> →	WHC/P
-----	-----	----	----	---------------------	-------

Complementary knobs C10 and C14 page → 8.50

# Stefano Orlati Handles

## Recessed Handles

	Centre (mm)	Length (mm)	Height (mm)	Width (mm)	Item number	Finish
<b>709</b> 	128	138	13	30	<b>SO-709-128</b> →	S
	<ul style="list-style-type: none"> <li>· Suit minimum 16mm board</li> <li>· Recess depth 10mm</li> </ul>					
<b>AHS403</b> 	128	145	16	42	<b>SO-AHS403-128</b> →	ABS
	160	172	16	42	<b>SO-AHS403-160</b> →	ABS
	128	145	16	42	<b>SO-AHS403-128</b> →	FS
	160	172	16	42	<b>SO-AHS403-160</b> →	FS
	<ul style="list-style-type: none"> <li>· Suit minimum 16mm board</li> <li>· Recess depth 14mm</li> <li>· ABS in this range is a dark version of the ABS finish</li> </ul>					



# Stefano Orlati Handles

## Square Handles

	Centre (mm)	Length (mm)	Height (mm)	Width (mm)	Item number	Finish
<b>116</b> 	128	159	29	15	<a href="#">SO-116-128</a> →	BN
	160	190	29	15	<a href="#">SO-116-160</a> →	BN
	128	159	29	15	<a href="#">SO-116-128</a> →	MC
	160	190	29	15	<a href="#">SO-116-160</a> →	MC
<b>288</b> 	96	109	36	16	<a href="#">SO-288-96</a> →	BN
	128	141	36	16	<a href="#">SO-288-128</a> →	BN
	160	173	36	16	<a href="#">SO-288-160</a> →	BN
	224	237	36	16	<a href="#">SO-288-224</a> →	BN
	288	301	36	16	<a href="#">SO-288-288</a> →	BN
<b>298</b> 	64	78	32	15	<a href="#">SO-298-64</a> →	BN
	128	142	32	15	<a href="#">SO-298-128</a> →	BN
	256	270	32	15	<a href="#">SO-298-256</a> →	BN
	64	78	32	15	<a href="#">SO-298-64</a> →	CH
	128	142	32	15	<a href="#">SO-298-128</a> →	CH
	256	270	32	15	<a href="#">SO-298-256</a> →	CH
	64	78	32	15	<a href="#">SO-298-64</a> →	MC
	128	142	32	15	<a href="#">SO-298-128</a> →	MC
	256	270	32	15	<a href="#">SO-298-256</a> →	MC

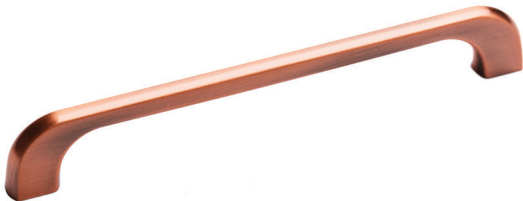

# Stefano Orlati Handles

## Square Handles

	Centre (mm)	Length (mm)	Height (mm)	Width (mm)	Item number	Finish
<b>305</b> 	128	145	25	12	SO-305-128 →	AC
	160	177	25	12	SO-305-160 →	AC
	224	241	27	12	SO-305-224 →	AC
	320	337	27	12	SO-305-320 →	AC
	128	145	25	12	SO-305-128 →	AI
	160	177	25	12	SO-305-160 →	AI
	224	241	27	12	SO-305-224 →	AI
	320	337	27	12	SO-305-320 →	AI
	128	145	25	12	SO-305-128 →	BN
	160	177	25	12	SO-305-160 →	BN
	224	241	27	12	SO-305-224 →	BN
	320	337	27	12	SO-305-320 →	BN
	128	145	25	12	SO-305-128 →	MC
	160	177	25	12	SO-305-160 →	MC
	224	241	27	12	SO-305-224 →	MC
	320	337	27	12	SO-305-320 →	MC
<b>422</b> 	64	76	30	18	SO-422-64-MB →	MB
	160	173	30	18	SO-422-160-BN →	BN
	160	173	30	18	SO-422-160-MB →	MB
	160	173	30	18	SO-422-160-TG →	TG
	320	333	30	18	SO-422-320-BN →	BN
	320	333	30	18	SO-422-320-MB →	MB
	320	333	30	18	SO-422-320-TG →	TG
	64	76	30	18	SO-422-64-BN →	BN
	64	76	30	18	SO-422-320-TG →	TG

# Stefano Orlati Handles

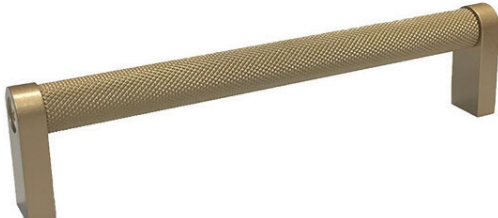
## Square Handles

	Centre (mm)	Length (mm)	Height (mm)	Width (mm)	Item number	Finish
<b>432</b> 	120	64	32	23	<a href="#">SO-432-64-PA</a>	PA
	160	210	32	23	<a href="#">SO-432-160-PA</a>	PA
	320	355	32	23	<a href="#">SO-432-320-PA</a>	PA
<b>454</b> 	160	168	40	16	<a href="#">SO-454-160-MB</a>	MB
	320	326	40	16	<a href="#">SO-454-320-MB</a>	MB
	160	168	40	16	<a href="#">SO-454-160-PA</a>	PA
	320	326	40	16	<a href="#">SO-454-320-PA</a>	PA
	160	168	40	16	<a href="#">SO-454-160-PG</a>	PG
	320	326	40	16	<a href="#">SO-454-320-PG</a>	PG
	160	168	40	16	<a href="#">SO-454-160-MBN</a>	MBN
	320	326	40	16	<a href="#">SO-454-320-PG</a>	MBN
<b>663</b> 	16	42	26	20	<a href="#">SO-663-16-MB</a>	MB
	128	157	32	18	<a href="#">SO-663-128-MB</a>	MB
	16	42	26	20	<a href="#">SO-663-16-CG</a>	CG
	128	157	32	18	<a href="#">SO-663-128-CG</a>	CG
	16	42	26	20	<a href="#">SO-663-16-TG</a>	TG
	128	157	32	18	<a href="#">SO-663-128-TG</a>	TG

# Stefano Orlati Handles

## Square Handles

	Centre (mm)	Length (mm)	Height (mm)	Width (mm)	Item number	Finish	
<b>800</b> 	76	84	32	8	<b>608.8M24.076.008</b>	SC	
	96	106	32	9.5	<b>608.8M24.096.008</b>	SC	
	128	138	32	9.5	<b>608.8M24.128.008</b>	SC	
	160	170	32	9.5	<b>608.8M24.160.008</b>	SC	
	192	202	32	9.5	<b>608.8M24.192.008</b>	SC	
	256	266	32	9.5	<b>608.8M24.256.008</b>	SC	
	96	106	32	9.5	<b>608.8M24.096.007</b>	CH	
	128	138	32	9.5	<b>608.8M24.128.007</b>	CH	
	192	202	32	9.5	<b>608.8M24.192.007</b>	CH	
	256	266	32	9.5	<b>608.8M24.256.007</b>	CH	
	<b>809</b>   Side Profile	96	108	18	12	<b>SO-809-96</b> →	BN
		160	178	18	12	<b>SO-809-160</b> →	BN
		256	274	20	12	<b>SO-809-256</b> →	BN
96		108	18	12	<b>SO-809-96</b> →	CH	
160		178	18	12	<b>SO-809-160</b> →	CH	
256		274	20	12	<b>SO-809-256</b> →	CH	
Complementary knob 809 page → 8.45							

# Stefano Orlati Handles

## Square Handles

1092



Centre (mm)	Length (mm)	Height (mm)	Width (mm)	Item number	Finish
96	102	27	11	SO-1092-96 →	MB
128	134	27	11	SO-1092-128 →	MB
160	166	27	11	SO-1092-160 →	MB
224	230	27	11	SO-1092-224 →	MB
288	294	27	11	SO-1092-288 →	MB
320	326	27	11	SO-1092-320 →	MB
96	102	27	11	SO-1092-96 →	BN
128	134	27	11	SO-1092-128 →	BN
160	166	27	11	SO-1092-160 →	BN
224	230	27	11	SO-1092-224 →	BN
288	294	27	11	SO-1092-288 →	BN
320	326	27	11	SO-1092-320 →	BN
96	102	27	11	SO-1092-96 →	CH
128	134	27	11	SO-1092-128 →	CH
160	166	27	11	SO-1092-160 →	CH
224	230	27	11	SO-1092-224 →	CH
288	294	27	11	SO-1092-288 →	CH
320	326	27	11	SO-1092-320 →	CH
96	102	27	11	SO-1092-96 →	MC
128	134	27	11	SO-1092-128 →	MC
160	166	27	11	SO-1092-160 →	MC
224	230	27	11	SO-1092-224 →	MC
288	294	27	11	SO-1092-288 →	MC
320	326	27	11	SO-1092-320 →	MC





# Stefano Orlati Handles

## Square Handles

	Centre (mm)	Length (mm)	Height (mm)	Width (mm)	Item number	Finish
<b>1745</b> 	128	137	28	21	<a href="#">SO-1745-128</a> →	BN
	192	201	28	21	<a href="#">SO-1745-192</a> →	BN
	256	265	28	21	<a href="#">SO-1745-256</a> →	BN
	128	137	28	21	<a href="#">SO-1745-128</a> →	MC
	192	201	28	21	<a href="#">SO-1745-192</a> →	MC
	256	265	28	21	<a href="#">SO-1745-256</a> →	MC

# Stefano Orlati Handles

## Square Handles

	Centre (mm)	Length (mm)	Height (mm)	Width (mm)	Item number	Finish
<b>3061</b> 	128	158	25	20	<a href="#">SO-3061-128</a> →	BN
	192	226	27	24	<a href="#">SO-3061-192</a> →	BN
	128	158	25	20	<a href="#">SO-3061-128</a> →	MC
	192	226	27	24	<a href="#">SO-3061-192</a> →	MC
<b>3064</b> 	128	157	27	8	<a href="#">SO-3064-128</a> →	PB
	160	192	27	8	<a href="#">SO-3064-160</a> →	PB
	128	157	27	8	<a href="#">SO-3064-128</a> →	SB
	160	192	27	8	<a href="#">SO-3064-160</a> →	SB
	96	121	27	8	<a href="#">SO-3064-96</a> →	BN
	128	157	27	8	<a href="#">SO-3064-128</a> →	BN
	160	192	27	8	<a href="#">SO-3064-160</a> →	BN
	192	224	27	8	<a href="#">SO-3064-192</a> →	BN
	240	273	27	8	<a href="#">SO-3064-240</a> →	BN
	320	355	27	8	<a href="#">SO-3064-320</a> →	BN
	96	121	27	8	<a href="#">SO-3064-96</a> →	MC
	128	157	27	8	<a href="#">SO-3064-128</a> →	MC
	160	192	27	8	<a href="#">SO-3064-160</a> →	MC
	192	224	27	8	<a href="#">SO-3064-192</a> →	MC
	240	273	27	8	<a href="#">SO-3064-240</a> →	MC
	320	355	27	8	<a href="#">SO-3064-320</a> →	MC

# Stefano Orlati Handles

## Square Handles

**3163**



Centre (mm)	Length (mm)	Height (mm)	Width (mm)	Item number	Finish
96	121	25	8	608.8J18.096.010	MB
128	161	25	8	608.8J18.128.010	MB
160	193	25	8	608.8J18.160.010	MB
192	225	25	8	608.8J18.192.010	MB
240	273	25	8	608.8J18.240.010	MB
96	121	25	8	608.8J18.096.003	BN
128	161	25	8	608.8J18.128.003	BN
160	193	25	8	608.8J18.160.003	BN
192	225	25	8	608.8J18.192.003	BN
240	273	25	8	608.8J18.240.003	BN

# Stefano Orlati Handles

## Square Handles

**3447**



Centre (mm)	Length (mm)	Height (mm)	Width (mm)	Item number	Finish
128	158	25	20	608.8018.128.003	BN
160	192	25	22	608.8018.160.003	BN
192	226	25	25	608.8018.192.003	BN
160	192	25	22	608.8018.160.010	MB



# Stefano Orlati Handles

## Square Handles

	Centre (mm)	Length (mm)	Height (mm)	Width (mm)	Item number	Finish
<b>4062</b> 	96	104	28	8	SO-4062-96 →	MB
	128	136	28	8	SO-4062-128 →	MB
	160	168	28	8	SO-4062-160 →	MB
	192	200	28	8	SO-4062-192 →	MB
	256	264	28	8	SO-4062-256 →	MB
	320	328	28	8	SO-4062-320 →	MB
	416	424	28	8	SO-4062-416 →	MB
	96	104	28	8	SO-4062-96 →	BN
	128	136	28	8	SO-4062-128 →	BN
	160	168	28	8	SO-4062-160 →	BN
	192	200	28	8	SO-4062-192 →	BN
	256	264	28	8	SO-4062-256 →	BN
	320	328	28	8	SO-4062-320 →	BN
	416	424	28	8	SO-4062-416 →	BN
	96	104	28	8	SO-4062-96 →	TG
	128	136	28	8	SO-4062-128 →	TG
	160	168	28	8	SO-4062-160 →	TG
	192	200	28	8	SO-4062-192 →	TG
	256	264	28	8	SO-4062-256 →	TG
	320	328	28	8	SO-4062-320 →	TG
	416	424	28	8	SO-4062-416 →	TG

# Stefano Orlati Handles

## Square Handles

	Centre (mm)	Length (mm)	Height (mm)	Width (mm)	Item number	Finish
<b>5012</b> 	96	156	30	12	608.8D10.096.003	BN
	128	188	30	12	608.8D10.128.003	BN
	160	220	30	12	608.8D10.160.003	BN
	256	316	30	12	608.8D10.256.003	BN
	320	380	30	12	608.8D10.320.003	BN
<b>5075</b> 	128	142	22	14	SO-5075-128 →	MBN
	192	206	22	14	SO-5075-192 →	MBN
	320	334	22	14	SO-5075-320 →	MBN
	128	142	22	14	SO-5075-128 →	CH
	192	206	22	14	SO-5075-192 →	CH
	320	334	22	14	SO-5075-320 →	CH
	128	142	22	14	SO-5075-128 →	SB
	192	206	22	14	SO-5075-192 →	SB
	320	334	22	14	SO-5075-320 →	SB
	128	142	22	14	SO-5075-128 →	TG
	192	206	22	14	SO-5075-192 →	TG
	320	334	22	14	SO-5075-320 →	TG

# Stefano Orlati Handles

## Square Handles

	Centre (mm)	Length (mm)	Height (mm)	Width (mm)	Item number	Finish
<b>5076</b> 	128	138	29	10	<a href="#">SO-5076-128 →</a>	CH
	192	202	29	10	<a href="#">SO-5076-192 →</a>	CH
	256	266	29	10	<a href="#">SO-5076-256 →</a>	CH
	320	330	29	10	<a href="#">SO-5076-320 →</a>	CH
	128	138	29	10	<a href="#">SO-5076-128 →</a>	MB
	192	202	29	10	<a href="#">SO-5076-192 →</a>	MB
	256	266	29	10	<a href="#">SO-5076-256 →</a>	MB
	320	330	29	10	<a href="#">SO-5076-320 →</a>	MB
	128	138	29	10	<a href="#">SO-5076-128 →</a>	BN
	192	202	29	10	<a href="#">SO-5076-192 →</a>	BN
	256	266	29	10	<a href="#">SO-5076-256 →</a>	BN
	320	330	29	10	<a href="#">SO-5076-320 →</a>	BN
<b>6330</b> 	128	142	30	25	<a href="#">SO-6330-128 →</a>	BN
	192	206	30	25	<a href="#">SO-6330-192 →</a>	BN
	256	269	30	25	<a href="#">SO-6330-256 →</a>	BN
	320	334	30	25	<a href="#">SO-6330-320 →</a>	BN

# Stefano Orlati Handles

## Square Handles

### 7011



Centre (mm)	Length (mm)	Height (mm)	Width (mm)	Item number	Finish
96	102	26	12	608.8R16.096.007	CH
128	134	26	12	608.8R16.128.007	CH
160	166	26	12	608.8R16.160.007	CH
256	262	26	12	608.8R16.256.007	CH
96	102	26	12	608.8R16.096.003	BN
128	134	26	12	608.8R16.128.003	BN
160	166	26	12	608.8R16.160.003	BN
256	262	26	12	608.8R16.256.003	BN
320	326	26	12	608.8R16.320.003	BN
448	454	26	12	608.8R16.448.003	BN

### 7105



96	102	30	20	608.8R18.096.003	BN
128	134	30	20	608.8R18.128.003	BN
160	166	30	20	608.8R18.160.003	BN
256	262	30	20	608.8R18.256.003	BN
320	326	30	20	608.8R18.320.003	BN



# Stefano Orlati Handles

## Square Handles

	Centre (mm)	Length (mm)	Height (mm)	Width (mm)	Item number	Finish
<b>7120</b> 	128	140	31	15	608.8A16.128.003	BN
	160	172	31	15	608.8A16.160.003	BN
	256	268	31	15	608.8A16.256.003	BN
<b>7128</b> 	128	178	32	11	608.8B17.128.003	BN
	160	210	32	11	608.8B17.160.003	BN
	256	306	32	11	608.8B17.256.003	BN
	320	370	32	11	608.8B17.320.003	BN
<b>7141</b> 	128	188	34	8	608.8B16.128.003	BN
	160	220	34	8	608.8B16.160.003	BN
	256	316	34	8	608.8B16.256.003	BN
	320	380	34	8	608.8B16.320.003	BN
	448	508	34	8	608.8B16.448.003	BN
<b>7202</b> 	96	111	28	12	608.8E18.096.003	BN
	128	144	28	12	608.8E18.128.003	BN
	160	176	28	12	608.8E18.160.003	BN
	256	272	28	12	608.8E18.256.003	BN
	320	337	28	12	608.8E18.320.003	BN

# Stefano Orlati Handles

## Square Handles

### 7292



Centre (mm)	Length (mm)	Height (mm)	Width (mm)	Item number	Finish
96	102	26	12	608.8R16.096.007	CH
128	134	26	12	608.8R16.128.007	CH
160	166	26	12	608.8R16.160.007	CH
256	262	26	12	608.8R16.256.007	CH
96	102	26	12	608.8R16.096.003	BN
128	134	26	12	608.8R16.128.003	BN
160	166	26	12	608.8R16.160.003	BN
256	262	26	12	608.8R16.256.003	BN
320	326	26	12	608.8R16.320.003	BN
448	454	26	12	608.8R16.448.003	BN

### 7298



96	102	30	20	608.8R18.096.003	BN
128	134	30	20	608.8R18.128.003	BN
160	166	30	20	608.8R18.160.003	BN
256	262	30	20	608.8R18.256.003	BN
320	326	30	20	608.8R18.320.003	BN

# Stefano Orlati Handles

## Square Handles

	Centre (mm)	Length (mm)	Height (mm)	Width (mm)	Item number	Finish
<b>8230</b> 	128	192	30	10	<b>SO-8230-128</b> →	ABS
	192	256	30	10	<b>SO-8230-192</b> →	ABS
	320	384	30	10	<b>SO-8230-320</b> →	ABS
	480	544	30	10	<b>SO-8230-480</b> →	ABS
<b>7092/08</b> 	96	104	27	8	<b>608.8B18.096.003</b>	BN
	128	136	27	8	<b>608.8B18.128.003</b>	BN
	160	168	27	8	<b>608.8B18.160.003</b>	BN
	256	264	27	8	<b>608.8B18.256.003</b>	BN
	320	328	27	8	<b>608.8B18.320.003</b>	BN
<b>7092/12</b> 	96	106	30	12	<b>608.8B19.096.003</b>	BN
	128	138	30	12	<b>608.8B19.128.003</b>	BN
	160	170	30	12	<b>608.8B19.160.003</b>	BN
	256	266	30	12	<b>608.8B19.256.003</b>	BN
	320	330	30	12	<b>608.8B19.320.003</b>	BN



# Stefano Orlati Handles

## Square Handles

	Centre (mm)	Length (mm)	Height (mm)	Width (mm)	Item number	Finish
<b>A</b> 	128	135	30	12	<a href="#">SO-A-128 →</a>	MB
	160	167	30	12	<a href="#">SO-A-160 →</a>	MB
	224	231	30	12	<a href="#">SO-A-224 →</a>	MB
	320	327	30	12	<a href="#">SO-A-320 →</a>	MB
	128	135	30	12	<a href="#">SO-A-128 →</a>	BN
	160	167	30	12	<a href="#">SO-A-160 →</a>	BN
	224	231	30	12	<a href="#">SO-A-224 →</a>	BN
	320	327	30	12	<a href="#">SO-A-320 →</a>	BN
	128	135	30	12	<a href="#">SO-A-128 →</a>	FS
	160	167	30	12	<a href="#">SO-A-160 →</a>	FS
	224	231	30	12	<a href="#">SO-A-224 →</a>	FS
	320	327	30	12	<a href="#">SO-A-320 →</a>	FS
<b>B</b> 	128	135	30	16	<a href="#">SO-B-128 →</a>	MB
	160	167	30	16	<a href="#">SO-B-160 →</a>	MB
	224	231	30	16	<a href="#">SO-B-224 →</a>	MB
	320	327	30	16	<a href="#">SO-B-320 →</a>	MB
	128	135	30	16	<a href="#">SO-B-128 →</a>	BN
	160	167	30	16	<a href="#">SO-B-160 →</a>	BN
	224	231	30	16	<a href="#">SO-B-224 →</a>	BN
	320	327	30	16	<a href="#">SO-B-320 →</a>	BN
	128	135	30	16	<a href="#">SO-B-128 →</a>	FS
	160	167	30	16	<a href="#">SO-B-160 →</a>	FS
	224	231	30	16	<a href="#">SO-B-224 →</a>	FS
	320	327	30	16	<a href="#">SO-B-320 →</a>	FS

# Stefano Orlati Handles

## Stainless Steel Handles

	Centre (mm)	Length (mm)	Height (mm)	Width (mm)	Item number	Finish
<b>D</b> 	96	106	37	10	SO-D-96 →	BN
	96	106	37	10	SO-D-96 →	MC
	128	138	37	10	SO-D-128 →	MC
<b>MH14</b> 	64	78	29	7	SO-MH14-64 →	BN
	96	110	29	7	SO-MH14-96 →	BN
	128	141	29	7	SO-MH14-128 →	BN
	224	238	29	7	SO-MH14-224 →	BN
	320	333	29	7	SO-MH14-320 →	BN
	64	78	29	7	SO-MH14-64 →	CH
	96	110	29	7	SO-MH14-96 →	CH
	128	141	29	7	SO-MH14-128 →	CH
	224	238	29	7	SO-MH14-224 →	CH
	320	333	29	7	SO-MH14-320 →	CH
	64	78	29	7	SO-MH14-64 →	S
	96	110	29	7	SO-MH14-96 →	S
	128	141	29	7	SO-MH14-128 →	S
	224	238	29	7	SO-MH14-224 →	S
	320	333	29	7	SO-MH14-320 →	S
	<b>OK90</b> 	128	149	24	7	SO-OK90-128 →

# Stefano Orlati Handles

## Stainless Steel Handles

	Centre (mm)	Length (mm)	Height (mm)	Width (mm)	Item number	Finish
<b>909</b> 	128	142	40	14	<a href="#">SO-909-128</a> →	SS
	160	174	40	14	<a href="#">SO-909-160</a> →	SS
	224	238	40	14	<a href="#">SO-909-224</a> →	SS
	320	334	40	14	<a href="#">SO-909-320</a> →	SS
	480	494	40	14	<a href="#">SO-909-480</a> →	SS
<b>6820</b> 	128	136	31	21	<a href="#">SO-6820-128</a> →	SS
	160	168	31	21	<a href="#">SO-6820-160</a> →	SS
	224	232	31	21	<a href="#">SO-6820-224</a> →	SS
	320	328	31	21	<a href="#">SO-6820-320</a> →	SS
	448	456	31	21	<a href="#">SO-6820-448</a> →	SS
<b>8513</b> 	128	150	40	13	<a href="#">SO-8513-128</a> →	SS
	160	182	40	13	<a href="#">SO-8513-160</a> →	SS
	192	214	40	13	<a href="#">SO-8513-192</a> →	SS
	224	246	40	13	<a href="#">SO-8513-224</a> →	SS
	352	374	40	13	<a href="#">SO-8513-352</a> →	SS
	554	576	40	13	<a href="#">SO-8513-554</a> →	SS

# Stefano Orlati Handles

## Stainless Steel Handles

	Centre (mm)	Length (mm)	Height (mm)	Width (mm)	Item number	Finish
<b>8721</b> 	128	138	33	19	SO-8721-128 →	SS
	160	170	33	19	SO-8721-160 →	SS
	192	202	33	19	SO-8721-192 →	SS
	224	234	33	19	SO-8721-224 →	SS
	320	330	33	19	SO-8721-320 →	SS
	448	458	33	19	SO-8721-448 →	SS
<b>SSD</b> 	128	138	33	10	SO-SSD-128 →	SS
	160	170	33	10	SO-SSD-160 →	SS
	192	202	33	10	SO-SSD-192 →	SS
	288	298	33	10	SO-SSD-288 →	SS
	352	362	33	10	SO-SSD-352 →	SS
	448	458	33	10	SO-SSD-448 →	SS
<b>SSTB</b> 	96	136	34	12	SO-SSTB-96 →	SS
	128	168	34	12	SO-SSTB-128 →	SS
	160	200	34	12	SO-SSTB-160 →	SS
	192	232	34	12	SO-SSTB-192 →	SS
	288	328	34	12	SO-SSTB-288 →	SS
	352	392	34	12	SO-SSTB-352 →	SS
	448	488	34	12	SO-SSTB-448 →	SS
	544	584	34	12	SO-SSTB-544 →	SS

# Stefano Orlati Handles

## Knobs

	Centre (mm)	Length (mm)	Height (mm)	Width (mm)	Item number	Finish
<b>139</b> 	K		27	29	<a href="#">SO-139-K →</a>	BN
	K		27	29	<a href="#">SO-139-K →</a>	CH
	K		27	29	<a href="#">SO-139-K →</a>	MC
<b>278</b> 	32	23	40	49	<a href="#">SO-278-32-MB →</a>	MB
	32	23	40	49	<a href="#">SO-278-32-BN →</a>	BN
	32	23	40	49	<a href="#">SO-278-32-TG →</a>	TG
<b>699</b> 	K	43	34	43	<a href="#">SO-699-K-MB →</a>	MB
	K	43	34	43	<a href="#">SO-699-K-BN →</a>	BN
	K	43	34	43	<a href="#">SO-699-K-TG →</a>	TG
<b>947</b> 	K	30	32	22	608.8K22.025.008	SC







# Stefano Orlati Handles

## Knobs

	Centre (mm)	Length (mm)	Height (mm)	Width (mm)	Item number	Finish
<b>1112</b> 	16	25	27	21	<b>SO-1112-16</b> →	BN
	16	25	27	21	<b>SO-1112-16</b> →	CH
	16	25	27	21	<b>SO-1112-16</b> →	MC
<b>1160L</b> 	K		28	25	<b>SO-1160L-K-BN</b>	BN
	K		28	25	<b>SO-1160L-K-MC</b>	MC
<b>1172</b> 	K		19	14	<b>SO-1172-K</b> →	MB
<b>1186K</b> 	K	38	25	19	<b>SO-1186-K</b> →	BSAT
	K	38	25	19	<b>SO-1186-K</b> →	BSBN
	Complementary handles 1208 page → 8.23 Complementary handles 1186 page → 8.23					

# Stefano Orlati Handles

## Knobs

	Centre (mm)	Length (mm)	Height (mm)	Width (mm)	Item number	Finish
<b>3318</b> 	16	39	18	21	<a href="#">SO-3318-16</a> →	CH
<b>3321</b> 	K		26	27	<a href="#">SO-3321-K</a> →	BN
	K		26	27	<a href="#">SO-3321-K</a> →	MC
<b>3440K</b> 	K	21	33	18	<a href="#">SO-3440-K</a> →	BN
	K	21	33	18	<a href="#">SO-3440-K</a> →	BSBN
	K	21	33	18	<a href="#">SO-3440-K</a> →	AC
	Complementary handles 1208 page → 8.23					
<b>3515</b> 	K		20	12	<a href="#">608.8K21.012.008</a>	SC
	K		25	20	<a href="#">608.8K21.020.008</a>	SC
	K		27	25	<a href="#">608.8K21.025.008</a>	SC

# Stefano Orlati Handles

## Knobs

	Centre (mm)	Length (mm)	Height (mm)	Width (mm)	Item number	Finish
<b>3801</b>  	K		25	33	<a href="#">SO-3801-K</a> →	AB
	K		25	33	<a href="#">SO-3801-K</a> →	BN
	K		25	33	<a href="#">SO-3801-K</a> →	CH
	K		25	33	<a href="#">SO-3801-K</a> →	P
Complementary handles 8391 page → 8.24 Complementary handles 8392 page → 8.24						
<b>8047</b>  	K		31	38	<a href="#">SO-8047-K</a> →	BN
	K		31	38	<a href="#">SO-8047-K</a> →	MC

# Stefano Orlati Handles

## Knobs

	Centre (mm)	Length (mm)	Height (mm)	Width (mm)	Item number	Finish
<b>8393</b> 	K	64	32	22	<b>SO-8393-K</b> →	P
Complementary handles 8391 page → 8.24 Complementary handles 8392 page → 8.24						
<b>8741</b> 	K		28	33	<b>SO-8741-K</b> →	BN
	K		28	33	<b>SO-8741-K</b> →	CH
	K		28	33	<b>SO-8741-K</b> →	AB
Complementary handle 8658 page → 8.24 Complementary handle 8407 page → 8.24						
<b>9909</b> 	K		15	45	<b>SO-9909-K</b> →	MB

# Stefano Orlati Handles

## Knobs

	Centre (mm)	Length (mm)	Height (mm)	Width (mm)	Item number	Finish
<b>C10</b> 	K		30	30	<b>SO-C10-K</b> →	WHC/P
Complementary handles C15 page → 8.25						
<b>C14</b> 	K	75	35	23	<b>SO-C14-K</b> →	WHC/P
Complementary handles C15 page → 8.25						
<b>GL02</b> 	K		28	35	<b>SO-GL02-K</b> →	CL/CH
Complementary handles C15 page → 8.25						
<b>GL03</b> 	K		32	35	<b>SO-GL03-K</b> →	CL/CH
Complementary handles C15 page → 8.25						

# Stefano Orlati Handles

## Knobs

	Centre (mm)	Length (mm)	Height (mm)	Width (mm)	Item number	Finish
<b>MJ002</b> 	K	52	18	9	SO-MJ002-K →	SN
<b>MJ003</b> 	K		25	30	SO-MJ003-K →	P
<b>CV30</b> 	K		30	30	608.8K20.030.003	BN
	K		30	30	608.8K20.030.007	CH
	K		30	30	608.8K20.030.008	SC

# Stefano Orlati Handles

## Push Button Locks

	Centre (mm)	Length (mm)	Width (mm)	Item number	Finish
<b>9010</b>	32	80	16	<b>608.8Z00.000.403</b>	SC
	· Suits 13mm - 18mm board thickness				