

General Hardware & Tools

General Hardware and Tools

Product Guide

Cabinet Hardware

	Page
Shelf Supports	5.4
Bump-ons, Protectors, Glides & Rails	5.6
Door Catches and Latches	5.10
Joiners and Connectors	5.13
Joining Plates	5.14
Brackets and Cable Entry Grommets	5.15
Clips	5.16
Castors	5.17
Bed Fittings	5.19

Furniture Locks

Cylinder Locks	5.20
Striker Plates	5.22
Central Locking Systems	5.23

General Hardware & Tools





Waste Plates	5.24
Drill Bits	5.25
Saw Blades	5.28
Files	5.29
Stan the Stand	5.29
Tool Storage	5.29
Liquid Laminate	5.30
Repair Crayons	5.31
Filler	5.32

Safety Materials

Nuisance Dust Mask	5.33
Disposable Respirators	5.33
Disposable Ear Plugs	5.33

Cabinet Hardware

Shelf Supports

		Finish	Diameter (mm)	Item number
Shelf Support, Flat 		Nickel Plated	5	605.8A38.119.650
		Nickel Plated	7.5	605.8A38.119.750
		Brass Bush	8	605.8A38.180.010
Made of steel				
Shelf Support Bush 		Nickel Plated	7.5	605.8A38.175.651
		Brass Pin	8	605.8A38.180.020
Made of steel				
Shelf Support with Safety Pin 	15 x 20mm	Nickel Plated	5	605.8A38.214.650
Made of steel				
Shelf Support with Safety Pin 		Clear	5	605.8A38.210.830
		White	5	605.8A38.210.877
Made of steel and plastic				
Shelf Support 		Nickel Plated	5	605.8A38.216.650
Made of steel				

Cabinet Hardware

Shelf Supports

		Finish	Diameter (mm)	Item number
3mm Shelf Support with Pin   <p>Made of zinc</p>		Nickel Plated	3	001912.847.311
Shelf Support, Rock-in  <p>Made of steel</p>		Nickel Plated	5	605.8A38.218.650
Shelf Support for Glass  <p>Made of steel and plastic</p>		Nickel Plated	5	605.8A38.220.650
Centre Clips   <p>.104.030 .104.020</p> <p>Made of plastic</p>	Without grommets	Clear		605.8A60.104.030
	With grommets	Clear		605.8A60.104.020
End Clips   <p>.106.030 .106.020</p> <p>Made of plastic</p>	Without grommets	Clear		605.8A60.106.030
	With grommets	Clear		605.8A60.106.020

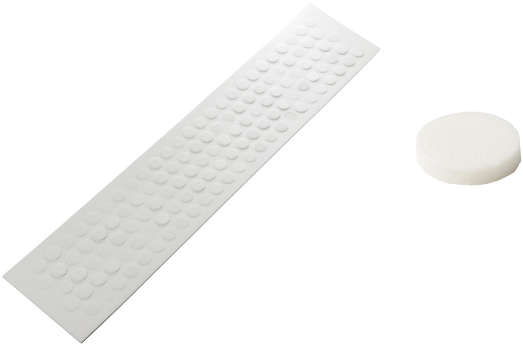

Cabinet Hardware

Bump Ons

		Thickness (mm)	Diameter (mm)	Item number
Clear Bump On 		3	10	605.8A28.000.030
		1.5	10	605.8A28.000.015
		2.2	7.9	605.8A28.079.022
		2.2	8.5	605.8A28.085.022
		4.8	9.5	605.8A28.095.048
		1.5	12.7	605.8A28.127.015
		3.8	12.7	605.8A28.127.038
Made of plastic				
White Bump On 		3	12	605.8A28.000.003
Made of foam				



Cabinet Hardware

Corner Protectors and Glides

	Colour	Length (mm)	Width (mm)	Item number
Corner Block 	Natural	45	20	605.8A36.045.200
	Natural	60	20	605.8A36.060.600
Made of plastic				
Corner Protector Glide 	White			605.8A36.050.001
Made of PVC				
Tack-on Glide 	Beige		16	605.A850.016.000
	Beige		19	605.A850.019.000
Made of Plastic				



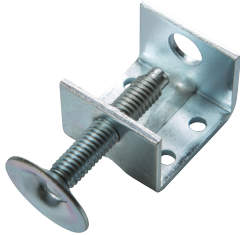

Cabinet Hardware

Plinths & Glides

		Length (mm)	Item number
Adjustable Plinth Foot Glide with Bracket and Cap		80	605.8A50.510.050
	Made of zinc-plated steel		
Adjustable Plinth Stem Glide	3/8 thread	50	605.8A50.538.025
	5/16 thread	50	605.8A50.516.025
	Made of steel and plastic		
Adjustable Glide Stem, Ø28mm Base	5/16 thread	50	605.8A50.516.050
	Made of steel and plastic		

Cabinet Hardware

Wedges, Rails & Filing Systems

	Finish	Dimensions (mm)	Length (mm)	Item number
<p>Snap-off Furniture Wedge</p>  <p>Made of plastic</p>	Brown			605.A850.600.004
<p>2 x 1 Pine Rail</p>  <p>Made of pine</p>	White		3600	605.8A10.019.361
<p>Filing System Frame</p>  <p>Made of steel</p>	Chrome	273 x 390 x 420		603.8C50.149.500
<p>Filing System Runner</p>  <p>Made of plastic</p>	White		2400	603.8C50.149.510

Cabinet Hardware

Door Catches and Latches

		Item number
Gripper Catch		605.8A36.010.010
	Made of steel and plastic	
Roller Catch		605.8A36.010.020
	Made of zinc	
Daisy Inline Catch		605.8A36.020.001
	Made of plastic	
Daisy Side Mount Catch		605.8A36.025.001
	Made of plastic	

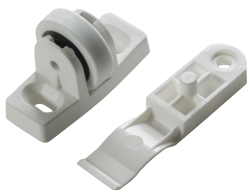

Cabinet Hardware

Door Catches and Latches

	Item number	White
<p>Mini Touch Latch</p>  <p>Made of steel and plastic</p>	605.8A36.010 →	030
<p>Corna Side Bi-fold Door Catch</p>  <p>Made of plastic</p>	605.8A36.030 →	001
<p>Corna Top Mount Catch</p>  <p>Made of plastic</p>	605.8A36.030 →	002

Cabinet Hardware

Door Catches

		Item number
<p>Corna Slide Door Protector Catch</p>  <p>Made of plastic</p>		605.8A36.030.003
<p>Magnetic Catch, 6kg</p>  <p>Made of steel and plastic</p>	<p>White</p> <p>Brown</p> <ul style="list-style-type: none"> Includes steel striker plate 	<p>605.8A36.040.061</p> <p>605.8A36.040.064</p>
<p>Catch Striker Plate</p>  <p>Made of steel</p>		<p>605.8A36.040.000</p> <ul style="list-style-type: none"> To use with magnetic catch

Cabinet Hardware

Joiners and Connectors

		Length (mm)	Width (mm)	Item number
Benchtop Connector, Ø35mm 	Ø35mm	65		605.8A24.035.065
	Ø35mm	150		605.8A24.150.065
Made of steel				
Zipbolt Benchtop Connector 	Ø25mm	85		605.8A24.025.025
	Ø35mm	85		605.8A24.085.035
Made of steel				
Benchtop Connector Plate, Black 		118	73	605.8A24.118.730
Made of plastic				
Steel Figure 8 Joiner 		29	16.5	605.8A24.080.000
Made of plastic and metal				
Wood Joiner Biscuits 	No. 0			605.8A26.021.000
	No. 5			605.8A26.021.050
	No. 10			605.8A26.021.010
	No. 20			605.8A26.021.020
Made of MDF				

Cabinet Hardware

Joining Plates

- Rigid and strong
- No pre-drilling
- Spacer pegs provide an even 2mm gap
- Sleek design



Technical Details

Item number

Nickel plated

Joining Plate, 105mm

360.1222 →

054.00

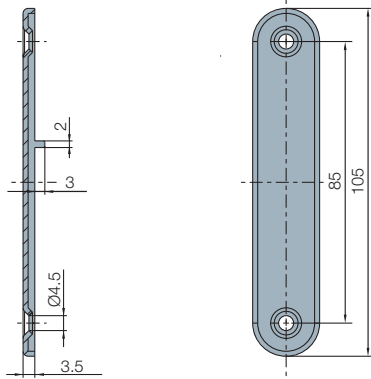

Made of steel

Joining Plate, 43mm

360.1230 →

054.00*

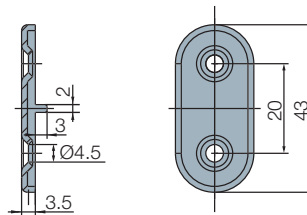

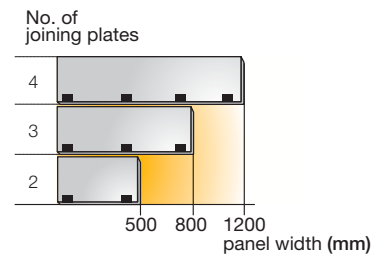
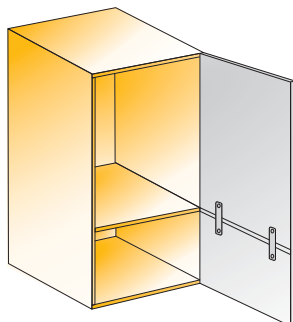

Made of steel

Recommended number of joining plates by panel width







Cabinet Hardware

Brackets, Cable Entry Grommets and Cap Holes

	Finish	Length (mm)	Width (mm)	Diameter (mm)	Item number
Angle Brackets  Made of steel	Zinc Plated	22	22		605.8A26.025.025
	Zinc Plated	38	38		605.8A26.038.038
	Zinc Plated	50	50		605.8A26.050.050
Cable Entry Grommets  Made of plastic	White			60	605.8A30.060.001
	Black			60	605.8A30.060.002
	Beige			60	605.8A30.060.003
	Cream			60	605.8A30.060.004
	Silver Grey			60	605.8A30.060.016
	Dove Grey			60	605.8A30.060.007
	White			80	605.8A30.080.001
	Black			80	605.8A30.080.002
	Beige			80	605.8A30.080.003
	Grey			80	605.8A30.080.007
	Silver Grey			80	605.8A30.080.016
Cap Holes  Made of plastic	White			35	605.8A31.035.001





Cabinet Hardware

Clips

		Size (mm)	Colour	Item number
Table Clip  <p>Made of steel</p>		3.65 x 18.5	Gold Zinc Plated	605.8A32.365.185
Playground Clip  <p>Made of steel</p>		60mm	Zinc Plated	605.8A32.500.000
Mirror Clip  <p>Made of plastic</p>		4mm	Clear Plastic	605.8A32.500.050
Cleat Easy Clip Connector  <p>Made of plastic</p>		50 x 16 x 20	White	605.8A36.056.080
Door Stop with Clip  <p>Made of plastic</p>			White	605.8A36.010.040

Cabinet Hardware

Castors

	Wheel diameter (mm)	Item number
<p>Castor, Unhooded with Socket</p>  <p>Made of plastic and steel</p>	40	605.8A50.402.000
<p>Castor, Hooded without Brake</p>  <p>Made of plastic and steel</p>	42	605.8A50.422.000
<p>Castor, Hooded Heavy Duty without Brake</p>  <p>Made of plastic and steel</p>	50	605.8A50.503.000
<p>Castor, Hooded Heavy Duty with Brake</p>  <p>Made of plastic and steel</p>	50	605.8A50.504.000



Cabinet Hardware

Castors

		Wheel diameter (mm)	Item number
Castor, Swivel, 30kg  .501.001 .502.001	With brake	50	605.8A50.501.001
	Without brake	50	605.8A50.502.001
Made of rubber			
Castor, Heavy Duty Rigid, 200kg 		80	605.8A50.801.002
Made of plastic			
Castor, Heavy Duty Swivel, 200kg  .803.000 .802.002	With brake	80	605.8A50.803.000
	Without brake	80	605.8A50.802.002
Made of plastic			

Cabinet Hardware

Bed Fittings

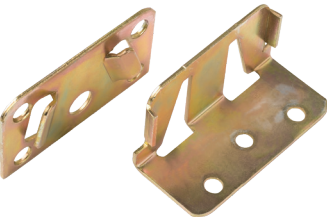
	Length (mm)	Item number
<p>Bed Bracket</p>  <p>Made of steel</p>	120	605.8B22.192.000
<p>Bed Fittings for Water Beds</p>  <p>Made of steel</p>	123	605.8B22.190.000
<p>Bed Fitting Centre Rail</p>  <p>Made of steel</p>	70	605.8B22.191.000



Furniture Locks

Cylinder Locks

	Lock type	Key type	Keyed	Item number	Nickel plated
601 Rim Lock Housing with Barrel and Key 	Rim	Barrel	Alike	605.8B10.601 →	001
	Rim	Barrel	Alike	605.8B10.601 →	002
	Rim	Barrel	Alike	605.8B10.601 →	003
	Rim	Barrel	Alike	605.8B10.601 →	004
	Rim	Barrel	Alike	605.8B10.601 →	005
	Rim	Barrel	Alike	605.8B10.601 →	006
	Rim	Barrel	Alike	605.8B10.601 →	007
	Rim	Barrel	To Differ	605.8B10.601 →	000
628 Double Door Lock Housing with Barrel and Key 	Double Door Rim	Barrel	Alike	605.8B10.628 →	001
	Double Door Rim	Barrel	Alike	605.8B10.628 →	002
604 Push Lock Housing with Barrel and Key 	Push	Barrel	Alike	605.8B10.604 →	001
	Push	Barrel	To Differ	605.8B10.604 →	000



Furniture Locks

Cylinder Locks

		Lock type	Key type	Keyed	Item number
611 Push Lock Housing with Barrel and Key 	Push	Cam	Barrel	Alike	605.8B10.611.001
	Push	Cam	Barrel	Alike	605.8B10.611.003
	Push	Cam	Barrel	Alike	605.8B10.611.004
	Push	Cam	Barrel	To Differ	605.8B10.611.000
CC Series Lock with Removable Barrel, Keyed Alike 			Barrel	Alike	605.8B10.215.000
	Master key		Barrel		605.8B10.205.000
	Removable key				

Furniture Locks

Striker Plates

		Item number
Right Angle Lock Striker Plate, 30mm		605.8B10.600.030
	Made of steel	
Standard Z Striker Plate for Double Door		605.8B10.600.020
	Made of steel	

Central Locking System

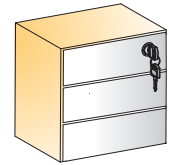

- Furniture lock with cylinder
- Screw-on mounting in front panel



Item number

Lock 605.8B10.000.000

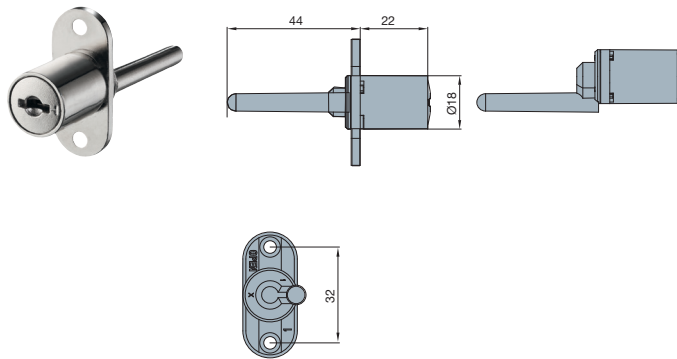

One set lock consists of

Lock 1 pce



Rosette 1 pce



Key 1 pair



Accessories

Bar Guide 605.8B10.010.000 3 pcs



Locking Pin L20005 3 pcs



Bar L=600mm 605.8B10.015.000 1 pce

L=1200mm L20016



Assembly

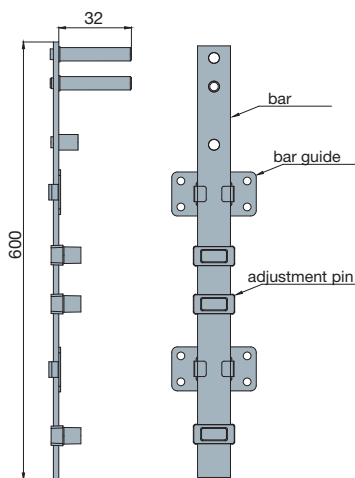

Mounting and drilling details

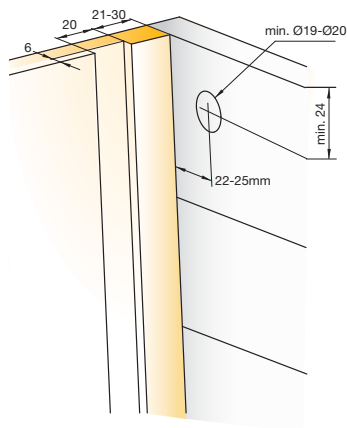

Made of steel

Chipboard screws for fixing 611.8K16.240.020

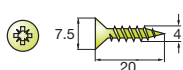

Builders Hardware



Waste Plates

- Cover for plumbing misplaced drilling
- Stick on around pipe to cover chips or oversized hole

		Size	Item number
 <p>Corna Plumbing Waste Plates</p> <p>Blank Sheet</p> <p>605.838.210.295</p>	210 x 295mm	605.838.210.295	
	40mm	605.838.040.000	
	50mm	605.838.050.000	
	65mm	605.838.065.000	
	Combination Pack	605.838.000.014	
	<ul style="list-style-type: none"> · Combination pack includes one each of 40mm, 50mm and 65mm 		
Made of steel			



General Hardware & Tools

Drill Bits

		Diameter (mm)	Item number
Pozidrive Drill Bit 	PZ2	25	605.8T10.325.000
	PZ2	50	605.8T10.350.000
Power Drill Bit 	PH2	152	605.8T10.205.000
Philips Head Drill Bits 	PH1	25	605.8T10.125.000
	PH2	25	605.8T10.225.000
	PH1	50	605.8T10.150.000
	PH2	50	605.8T10.250.000

General Hardware & Tools



Drill Bits

	Diameter (mm)	Item number
Snappy Countersunk Drill Bit 	1/8	605.8T60.000.018
Jobber Drill Bit 	5/64	605.8T50.343.564
	7/64	605.8T50.343.764
	1/18	605.8T50.343.180
Tungsten Drill Bits, 57mm 	Right-hand 5 Left-hand 5 Right-hand 8 Left-hand 8 Right-hand 10 Left-hand 10 Right-hand 35	605.8T40.157.105 605.8T40.157.005 605.8T40.157.008 605.8T40.157.108 605.8T40.257.010 605.8T40.157.010 605.8T40.257.035
Made of tungsten carbide		

Magnetic Drill Bit Holder
605.8T10.000.000

General Hardware & Tools

Drill Twists

	Diameter (mm)	Item number
<p>Twist Drill Bit, Imperial</p> 	1/8	605.8T50.343.018
<p>Drill Twists, Metric</p> 	2.5	605.8T50.343.025
	3	605.8T50.343.030
	3.5	605.8T50.343.035
	4	605.8T50.343.040
	5	605.8T50.343.050



General Hardware & Tools

Saw Blades

	Teeth	Style	Cut direction	Item number
Makita Jigsaw Blades, 5 pack 	2.9	B10	Upward Cut	605.8T41.010.000
	2.8	B11	Upward Cut	605.8T41.011.000
	4.2	B12	Upward Cut	605.8T41.012.000
	2.1	B19	Downward Cut	605.8T41.019.000
Jigsaw Blades 	4.0	T144D	Upward Cut	605.8T40.144.000
Reversible Planer Saw Blade 				605.8T35.000.050

General Hardware & Tools

General Hardware

		Item number
Handy Files		605.8T70.000.000
Stan the Stand		Stand 605.8T90.000.000
		Extension Kit 605.8T90.005.000
		PVC Covers 605.8T90.010.000
Storage Boxes		Exacta Pak - Large 605.8T90.015.000
		Multi 10 Pack - Small 605.8T90.020.000
Made of plastic		

General Hardware & Tools

Liquid Laminate

- 6 bottles in each pack
- Available in a variety of colours
- Hide small damage done to furniture

Liquid Laminate, 15ml



Colour	Item number
White	605.8L50.301.001
Black	605.8L50.301.002
Marl Beige	605.8L50.301.003
Antique White	605.8L50.301.004
Parchment	605.8L50.301.005
Charcoal	605.8L50.301.006
Folk / Oyster Grey	605.8L50.301.007
Alabaster	605.8L50.301.008
Classic Beige	605.8L50.301.009
Cappucino	605.8L50.301.010
Mushroom Linea	605.8L50.301.011
Oyster Linea	605.8L50.301.012
Paperbark	605.8L50.301.013
Select Beech	605.8L50.301.028
Young Beech	605.8L50.301.036

General Hardware & Tools

Repair Crayons

- 12 crayons in each pack
- Available in a variety of colours
- Hide small damage done to furniture

Repair Crayons



Colour	Item number
White	605.8L50.300.001
Black	605.8L50.300.002
Marl Beige	605.8L50.300.003
Antique White	605.8L50.300.004
Parchment	605.8L50.300.005
Gunmetal	605.8L50.300.006
Folk/Oyster Grey	605.8L50.300.007
Ironstone	605.8L50.300.008
Baltic Pine	605.8L50.300.010
Birch	605.8L50.300.012
Cherry	605.8L50.300.014
Dark Teak	605.8L50.300.016
Dark Walnut	605.8L50.300.018
Graceful Oak	605.8L50.300.020
Jarrah	605.8L50.300.022
Light Teak	605.8L50.300.024
Red Cherry	605.8L50.300.026
Select Beech	605.8L50.300.028
Tasmanian Oak	605.8L50.300.030
Walnut	605.8L50.300.032
Wild Birch	605.8L50.300.034
Young Beech	605.8L50.300.036
Various Colours	605.8L50.300.000

General Hardware & Tools



Filler

- Water-based
- 4-in-1 Woodputty, Grainfiller, Edgefiller and Crackfiller
- Non-flammable, non-toxic and can be used to the last gram

	Size (kg)	Colour	Item number
 <p>Timbermate Filler</p>	2	Ebony	605.8L50.302.202
	2	Hardwood	605.8L50.302.203
	8	Hardwood	605.8L50.302.803
	2	Oak	605.8L50.302.230
	2	Pine	605.8L50.302.210
	8	Pine	605.8L50.302.810
	2	Teak	605.8L50.302.224
	2	Walnut	605.8L50.302.232
	2	White	605.8L50.302.201

General Hardware & Tools

Safety Materials

	Item number
<p>Nuisance Dust Mask</p> 	605.8T90.035.000
<p>Disposable Respirator with Valve, 12 pack</p> 	605.8T90.040.000
<p>Pro-plug Disposable Ear Plugs, Uncorded, 200 Pair</p> 	605.8T90.045.000