



**Tekform  
Slimline  
Drawer**

**2018**



# Important Information

## Technical information

While every effort has been made in the production of this catalogue to ensure the accuracy of information, our products are continually being revised and users should confirm the up to date specification before ordering. Due to constant improvement of products presented in the catalogue, we can make changes at any time and without notice.

## Responsibility

It is the responsibility of the user to ensure the fitness of hardware for the intended purpose. We recommend assessment by appropriate testing in the application and by technical enquiry to our representatives.

## Intellectual property

Titus Group owns the intellectual property rights in its products worldwide whether as trademarks, patents, intellectual, copyright, designs, illustrations, drawings and the 'know-how' contained in their design and production. Titus Group respects the equivalent rights in competitors and all other relevant product design rights. To our knowledge our products do not infringe any intellectual property rights of competitors or other parties. Titus Group takes infringements of its rights seriously and will rigorously defend these rights to the full extent of the law.

## \*Non-preferred articles

All item numbers in the catalogue marked with \* are for non preferred items available on extended delivery times.

## Trademarks

Titus and Titusonic are registered trademarks of Titus International Ltd. Lama is a registered trademark of Titus d.o.o. Dekani, WoodWelding is a registered trademark of WW SA.

# Tekform Slimline Drawer

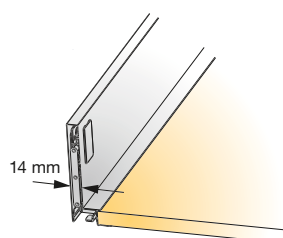

## Narrow sides

- Sleek look with 14mm thickness
- Efficient utilisation of drawer space

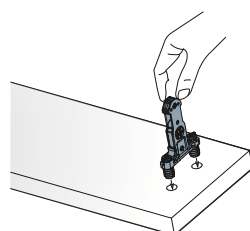

## 'EasyFix' front panel connector

- Hand insertion
- Quarter turn lock
- Repeatable assembly and disassembly possible

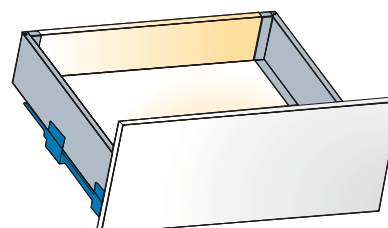

## Flexibility of runner system

- Same machinery settings as Tekform Double Wall Drawer
- Same drilling specifications as Tekform Double Wall Drawer

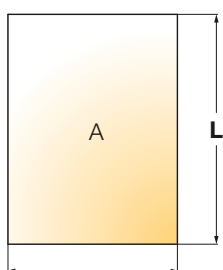

bottom panel width  
tolerance +/- 1mm

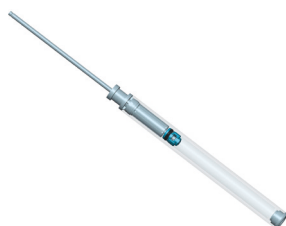

### Expanded tolerances

- Precise drawer alignment
- Smooth and silent operation
- Improved drawer stability in open position
- +/-1mm tolerance on bottom panel width size

### Titus damper inside

- Life-long consistent soft closing performance at various closing speeds
- 'ConfidentClose' - fast closing, late start deceleration action, quiet landing
- Low pull-out force

# Tekform Slimline Drawer

## Product Guide

Page

### Tekform Slimline Drawer

Tekform Slimline Drawer DW70

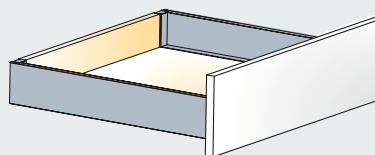

14

Tekform Slimline Drawer DW100

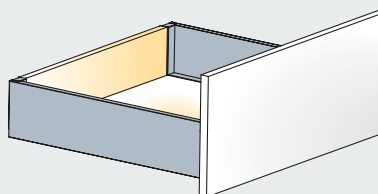

16

Tekform Slimline Drawer DW145

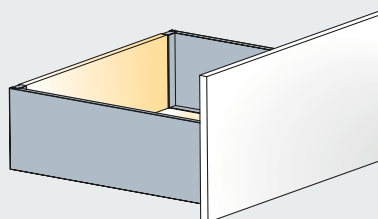

18

Tekform Slimline Drawer DW182

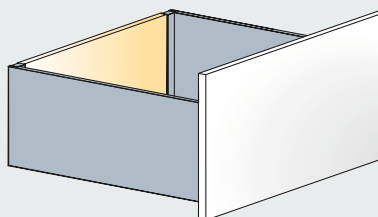

20

### Inner Slimline Drawer Fronts

Inner drawer front for  
Tekform Slimline Drawer  
DW70

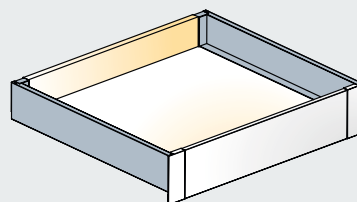

22

Inner drawer front for  
Tekform Slimline Drawer  
DW70 with glass

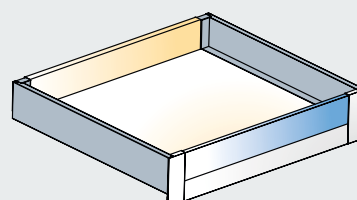

24

Page

Inner drawer front for  
Tekform Slimline Drawer  
DW145 with bar

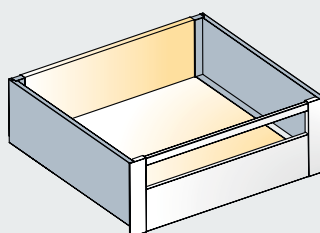

26

Inner drawer front for  
Tekform slimline Drawer  
DW145 with glass

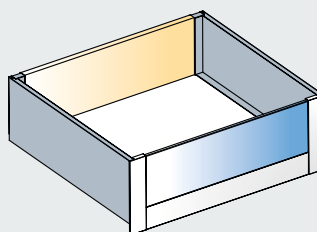

28

Inner drawer front for  
Tekform Slimline Drawer  
DW182 with bar

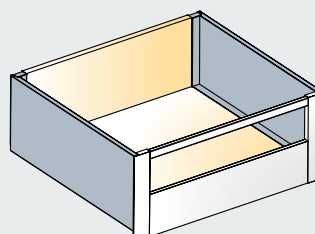

30

Inner drawer front for  
Tekform Slimline Drawer  
DW182 with glass

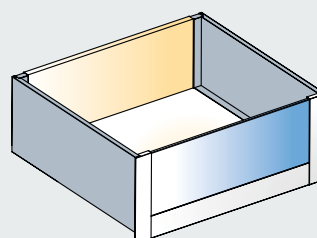

32

# Tekform Slimline Drawer Information

## Technical Guide

### How to choose the appropriate drawer dimension?

Select the drawer size based on available cabinet space. Please refer to the chart below with indicated minimum space

required in cabinet to choose appropriate drawer system.

Tekform Drawer nominal length (NL) in mm

NL	270	300	350	400	450	500	550
----	-----	-----	-----	-----	-----	-----	-----

	Tekform Drawer	
	Min. height (H) required	Cabinet depth (D)
<b>Tekform Slimline Drawer DW70</b>	115mm	NL+min 3mm
<b>Tekform Slimline Drawer DW100</b>	147mm	NL+min 3mm
<b>Tekform Slimline Drawer DW145</b>	198mm	NL+min 3mm
<b>Tekform Slimline Drawer DW182</b>	230mm	NL+min 3mm

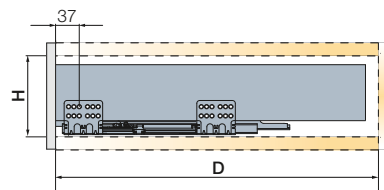

### How to fix drawer sides to the front panel?

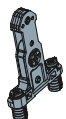

#### 'EasyFix' front connector

The Tekform Drawer is available with 'EasyFix' or screw-in front connectors.

- Hand insertion
- Quarter turn locking system
- Expandable plastic dowel
- Easy assembly and disassembly of front panel

Front connector

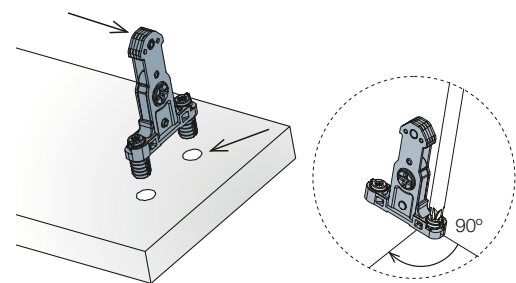

#### Screw-in front connector

- Reliable connection
- Fixing with Ø3.5x15mm screw (screws are not included)

Front connector

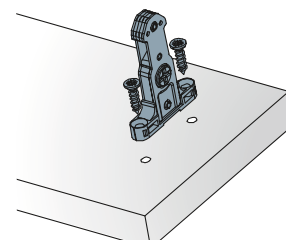



### Bottom panel and back panel cutting dimensions

Dimensions of bottom and back panel depends on:

- cabinet width
- nominal drawer length
- drawer height

Tekform Drawer nominal length (NL) in mm

NL	270	300	350	400	450	500	550
----	-----	-----	-----	-----	-----	-----	-----

Cabinet width

ECW: External cabinet width  
ICW: Internal cabinet width  
NL: Nominal length of drawer

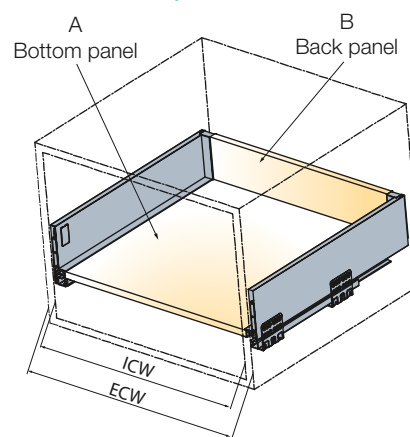

### Back panel cutting dimensions

Back panel height depends on the selected drawer height:

	H back panel
<b>SDW70</b>	68
<b>SDW100</b>	100
<b>SDW145</b>	151
<b>SDW182</b>	183

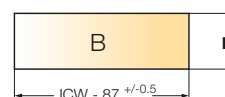

### Bottom panel cutting dimensions

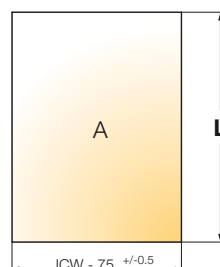

NL	270	300	350	400	450	500	550
<b>L</b>	260	290	340	390	440	490	540

NL= Tekform Drawer nominal length (in mm)

# Tekform Slimline Drawer Information

## Technical Guide

How to choose the appropriate drawer runner fixing positions?

Drawer fixing positions depend on the chosen drawer front type.

Tekform Slimline Drawer with standard front

When a standard drawer front is applied, use the third hole on the drawer runner for fixing.

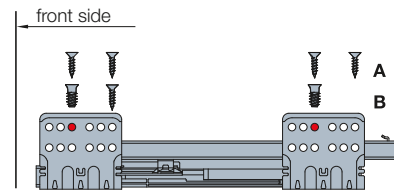

Tekform Slimline Drawer with inner front

When an inner drawer front is applied, use the second hole on the drawer runner for fixing.

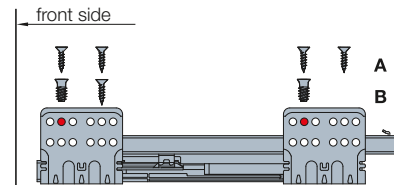

Load capacity

Drawer load capacity is 40 kg.

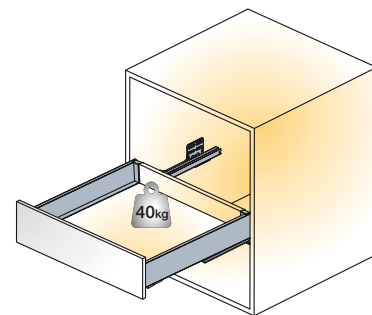

Expanded tolerances

Tekform drawers provide expanded tolerances in cabinet construction and assure:

- precise drawer alignment
- smooth and silent operating
- improved drawer stability in open position
- Tekform drawers provide tolerance of +/- 1mm on bottom panel width size

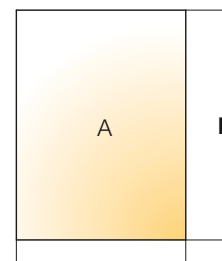

bottom panel width tolerance +/- 1mm



Adjustment needs to be done on both sides of the drawer

## Adjustments

### Side adjustment

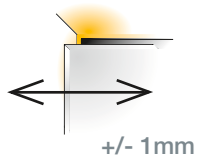

Side adjustment is done via the adjustment screw on the drawer side.

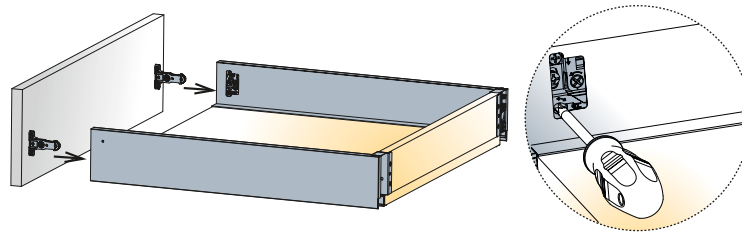

### Height adjustment

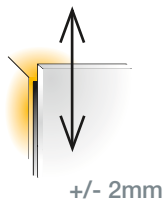

Height adjustment is done via the cam. First, release the locking screw and tighten it back after the front is adjusted.

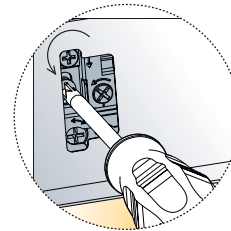
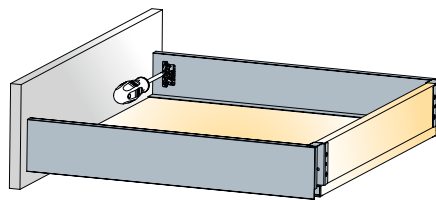

Release

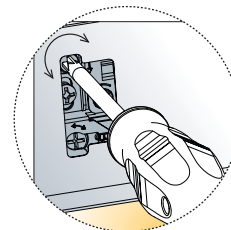
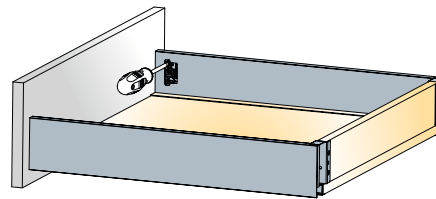

Adjust

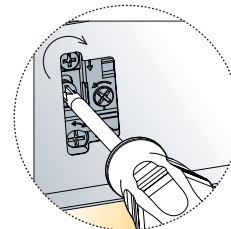
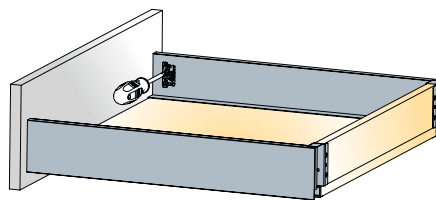

Tighten

## Key Design Choices

### 'ConfidentClose'

Fast closing

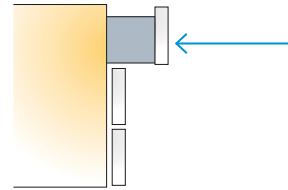

Late start of deceleration action

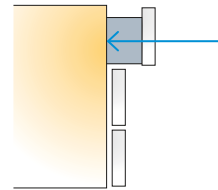

Quiet landing

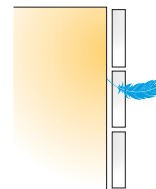

### CAF Consumer Assembly Friendliness

'EasyFix' front panel connector with expandable plastic dowel provides:

- quick, tool-free insertion
- quarter turn lock
- repeatable assembly and disassembly

Front connector

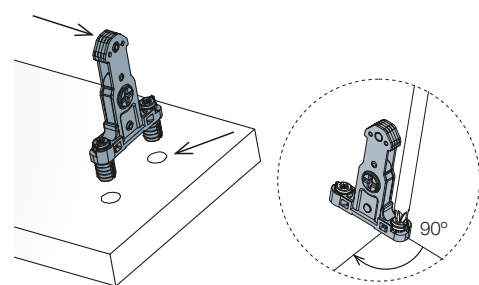

### Titus hydraulic damper

Designed and produced in-house.

- Reliable and consistent life-long damping
- Smooth closing
- Dampers' consistency over high volume production runs assured
- 100% automated quality check

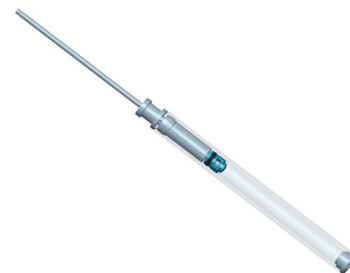

### Damping action

Even and smooth soft closing action.

- Soft and reliable closing

Damping force



Flat damping curve shows the uniform action produced during damper closing at a defined speed.



# Tekform Slimline Drawer DW70

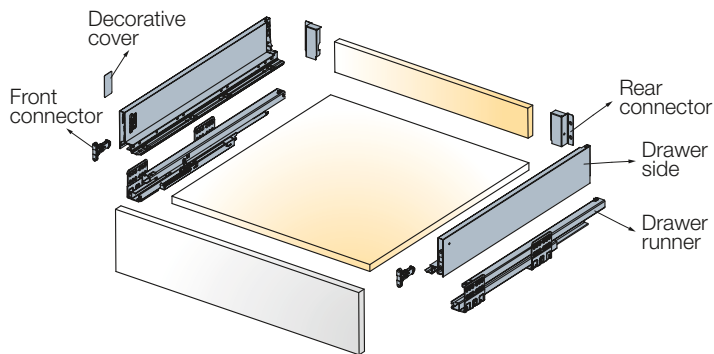
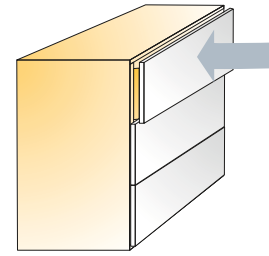

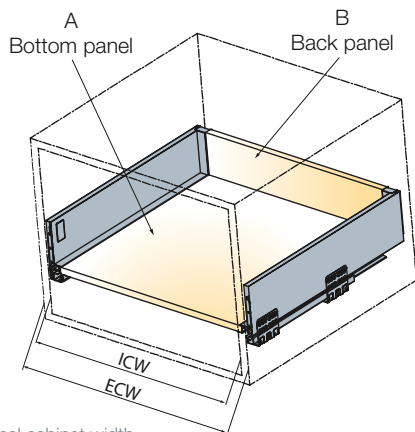

### Cutting dimensions details

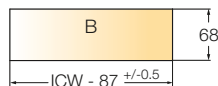
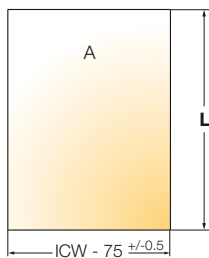

ECW: External cabinet width  
ICW: Internal cabinet width  
NL: Nominal length of drawer



L = NL - 10  
For further explanation → see page 9

Nominal length (mm)	with EasyFix front connector	with Screw-in front connector		
	Item number for a set	Item number for a set	White	Anthraccite grey
270	655.8T27 →	655.8E27 →	150.00	185.00
300*	655.8T30 →	655.8E30 →	150.00	185.00
350	655.8T35 →	655.8E35 →	150.00	185.00
400	655.8T40 →	655.8E40 →	150.00	185.00
450	655.8T45 →	655.8E45 →	150.00	185.00
500	655.8T50 →	655.8E50 →	150.00	185.00
550	655.8T55 →	655.8E55 →	150.00	185.00
<b>One set consists of</b>				
	Drawer sides		2 pcs	
	Drawer runners		2 pcs	
	^Front connectors		2 pcs	
	Rear connectors		2 pcs	
	Covers		2 pcs	
	Mounting instructions		1 pce	

Screws not included. ^Front connectors determined by order code.

- Drawer runner type
- Load capacity
- Minimum height space required
- Wooden back panel thickness
- Wooden bottom panel thickness

Full extension  
40kg  
115mm  
16mm  
16mm

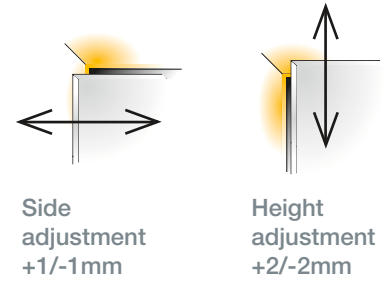

For further explanation → see page 11

Installation dimensions

Minimum space required for the cabinet

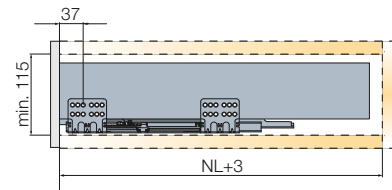

Drilling dimensions for the front panel

EasyFix attachment

Screw-in attachment

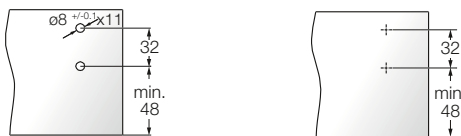

Mounting dimensions for the back panel

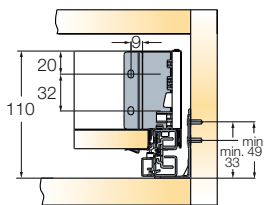

Installation dimensions for the front panel

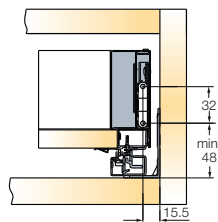

Drawer runner fixing positions

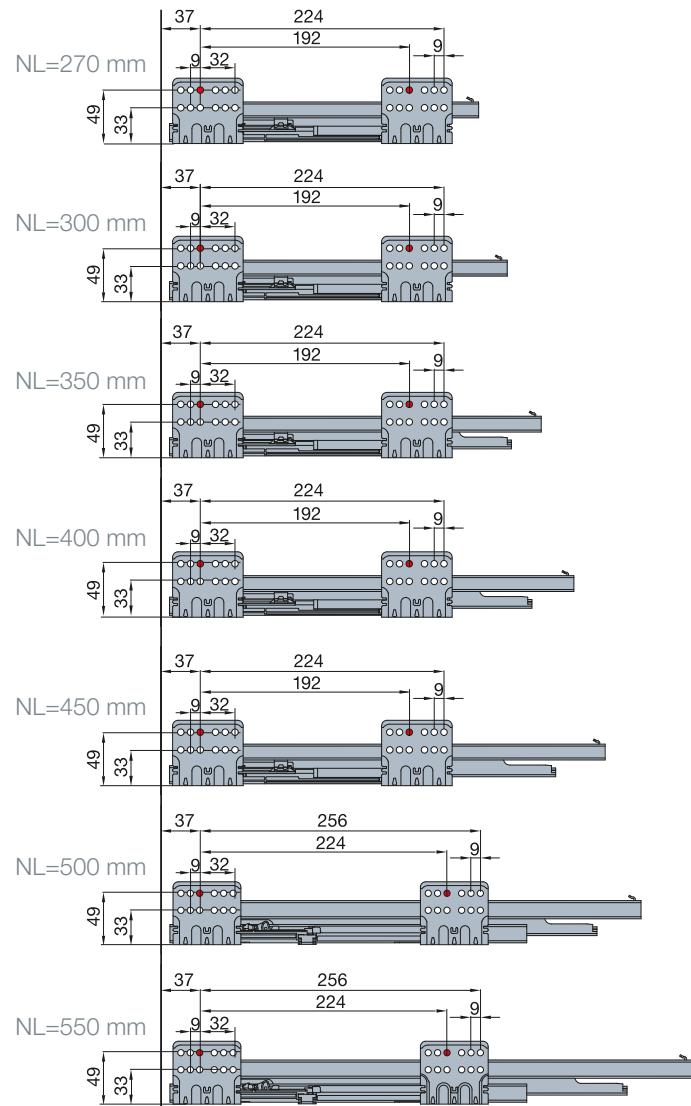
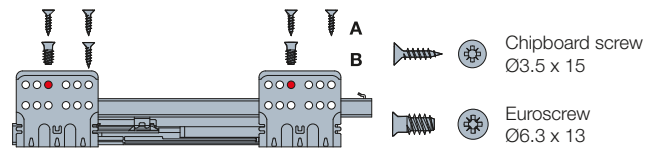

A trial mounting is always recommended. For further information please contact Titus Tekform. Download supporting documentation from the Titus Tekform website [titustekform.com.au](http://titustekform.com.au)

# Tekform Slimline Drawer DW100

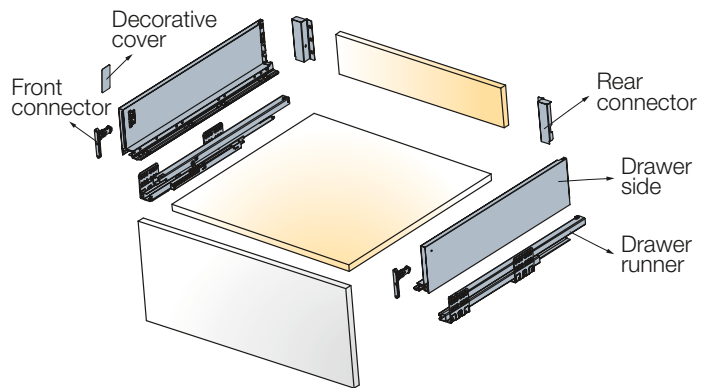
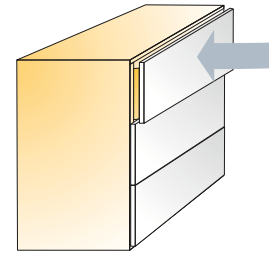

### Cutting dimensions details

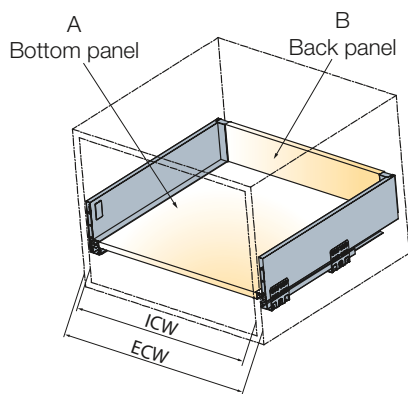



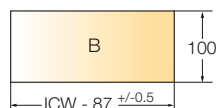
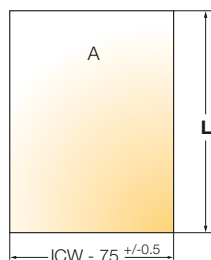

ECW: External cabinet width  
ICW: Internal cabinet width  
NL: Nominal length of drawer



$L = NL - 10$

For further explanation → see page 9

Nominal length (mm)	with EasyFix front connector	with Screw-in front connector	Color	
	Item number for a set	Item number for a set	White	Antracite grey
270	655.8U27 →	655.8F27 →	150.00	185.00
300*	655.8U30 →	655.8F30 →	150.00	185.00
350	655.8U35 →	655.8F35 →	150.00	185.00
400	655.8U40 →	655.8F40 →	150.00	185.00
450	655.8U45 →	655.8F45 →	150.00	185.00
500	655.8U50 →	655.8F50 →	150.00	185.00
550	655.8U55 →	655.8F55 →	150.00	185.00
<b>One set consists of</b>				
	Drawer sides		2 pcs	
	Drawer runners		2 pcs	
	^Front connectors		2 pcs	
	Rear connectors		2 pcs	
	Covers		2 pcs	
	Mounting instructions		1 pce	

Screws not included. ^Front connectors determined by order code.



- Drawer runner type
- Load capacity
- Minimum height per drawer required
- Wooden back panel thickness
- Wooden bottom panel thickness

Full extension  
40kg  
147mm  
16mm  
16mm

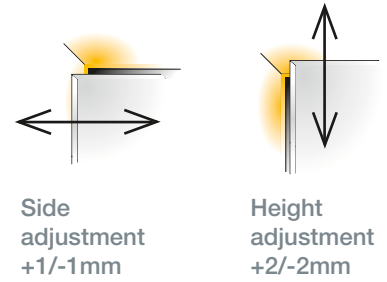

For further explanation → see page 11

Installation dimensions

Drawer runner fixing positions

Minimum space required for the cabinet

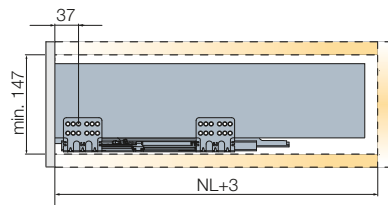

Drilling dimensions for the front panel

EasyFix attachment

Screw-in attachment

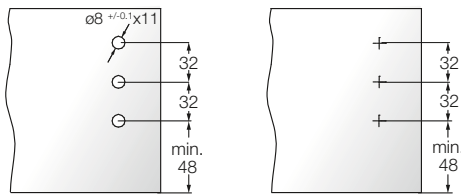

Mounting dimensions for the back panel

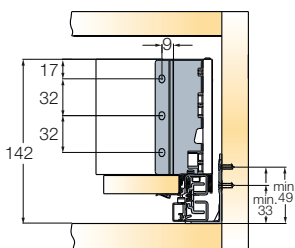

Installation dimensions for the front panel

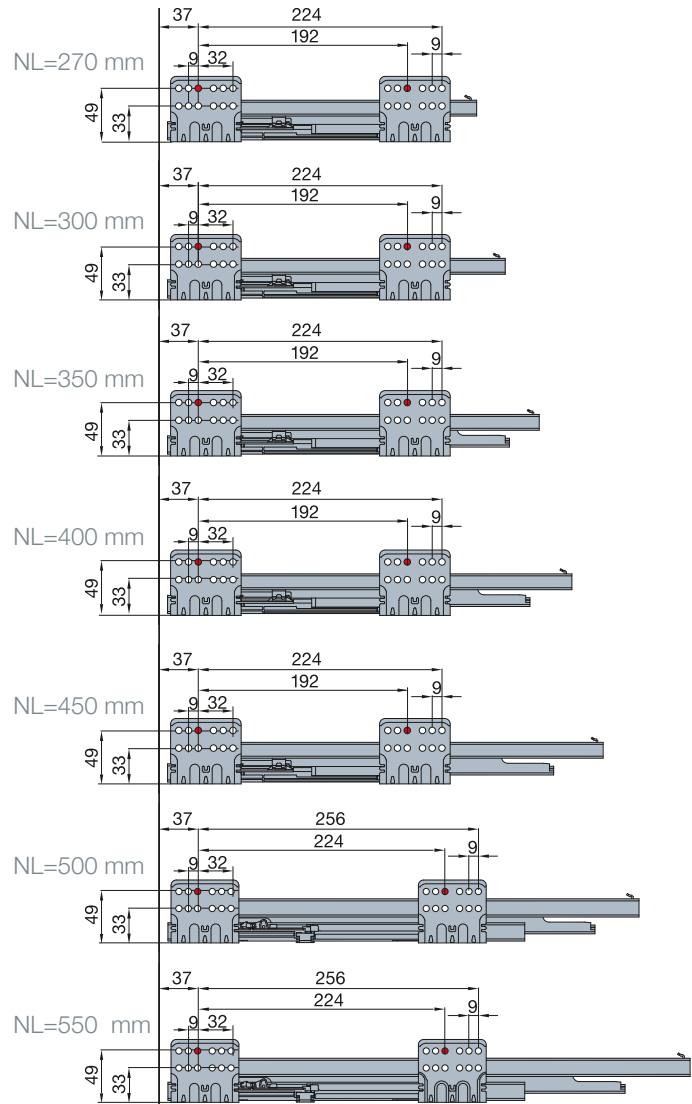
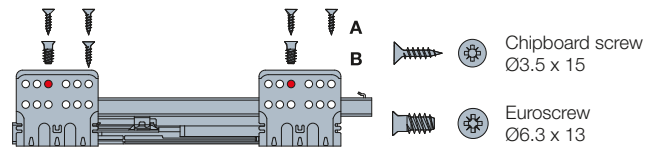
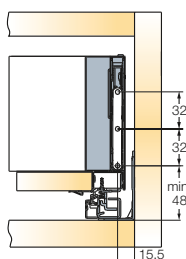

A trial mounting is always recommended. For further information please contact Titus Tekform. Download supporting documentation from the Titus Tekform website [titustekform.com.au](http://titustekform.com.au)

# Tekform Slimline Drawer DW145

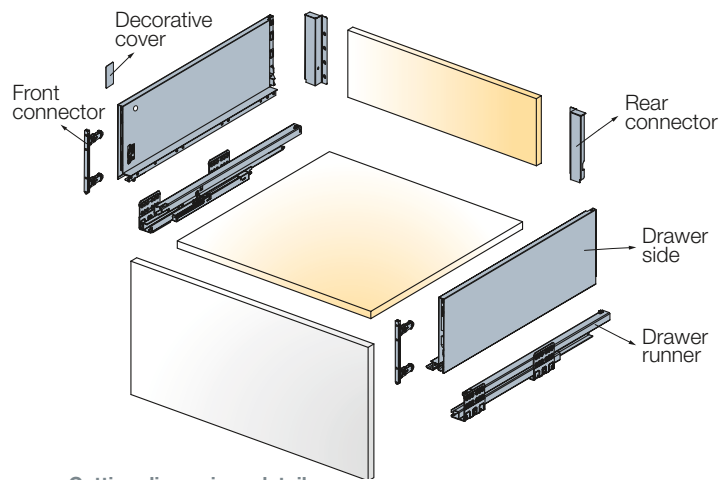
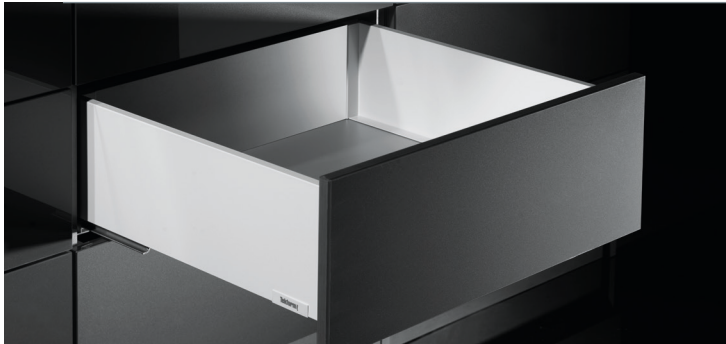
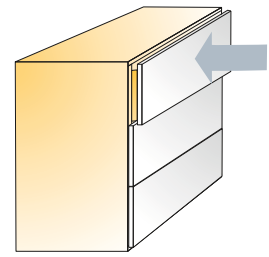



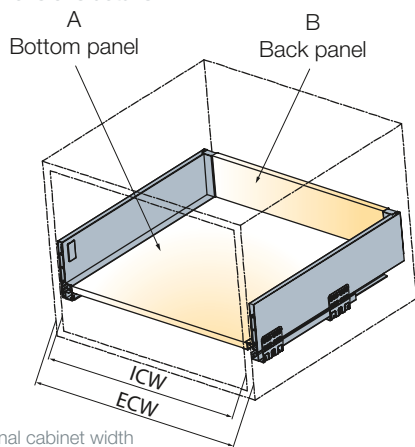

### Cutting dimensions details

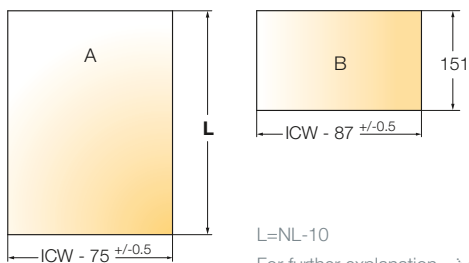

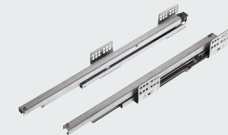
ECW: External cabinet width  
ICW: Internal cabinet width  
NL: Nominal length of drawer



Nominal length (mm)	with EasyFix front connector	with Screw-in front connector	Color	
	Item number for a set	Item number for a set	White	Anthracite grey
270	655.8V27 →	655.8G27 →	150.00	185.00
300*	655.8V30 →	655.8G30 →	150.00	185.00
350	655.8V35 →	655.8G35 →	150.00	185.00
400	655.8V40 →	655.8G40 →	150.00	185.00
450	655.8V45 →	655.8G45 →	150.00	185.00
500	655.8V50 →	655.8G50 →	150.00	185.00
550	655.8V55 →	655.8G55 →	150.00	185.00
<b>One set consists of</b>				
	Drawer sides		2 pcs	
	Drawer runners		2 pcs	
	^Front connectors		2 pcs	
	Rear connectors		2 pcs	
	Covers		2 pcs	
	Mounting instructions		1 pce	

Screws not included. ^Front connectors determined by order code.

- Drawer runner type
- Load capacity
- Minimum height per drawer required
- Wooden back panel thickness
- Wooden bottom panel thickness

Full extension  
40kg  
198mm  
16mm  
16mm

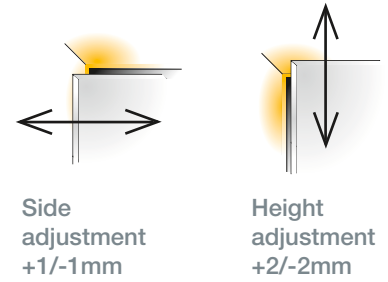

For further explanation → see page 11

Installation dimensions

Minimum space required for the cabinet

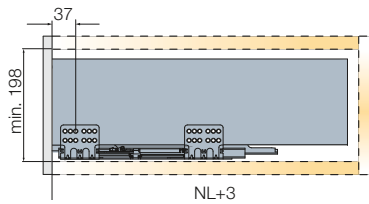

Drilling dimensions for the front panel

EasyFix attachment

Screw-in attachment

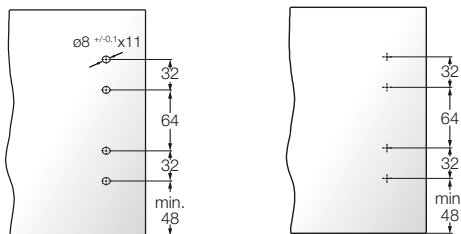

Mounting dimensions for the back panel

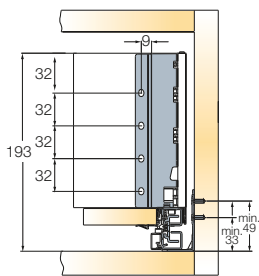

Installation dimensions for the front panel

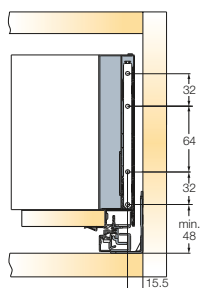

Drawer runner fixing positions

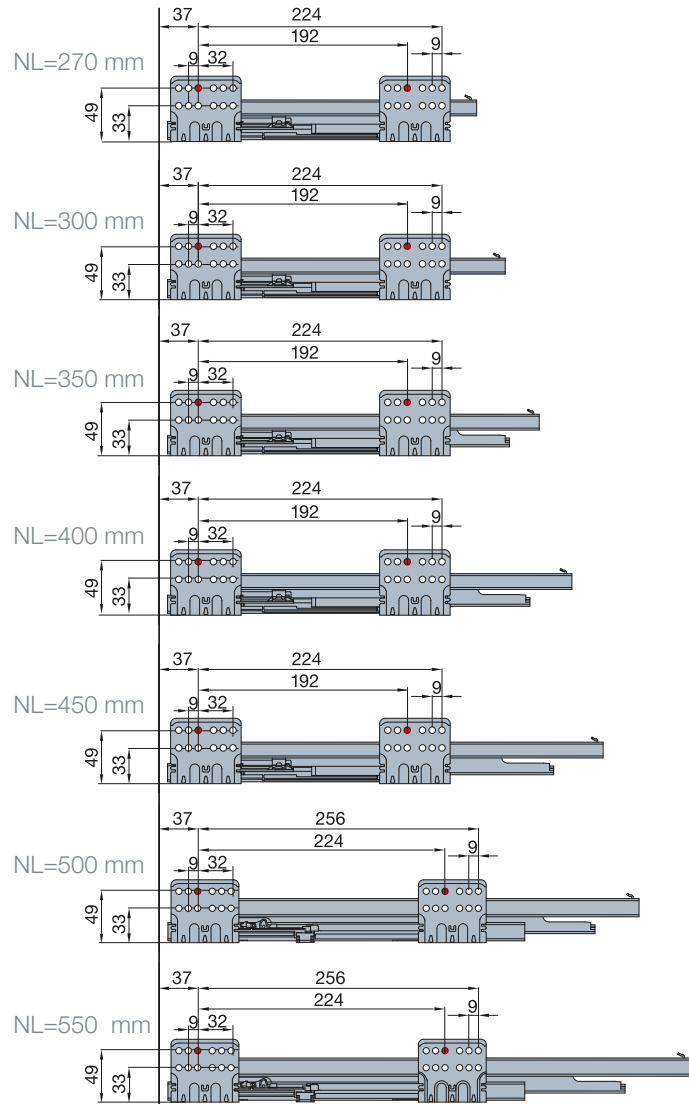
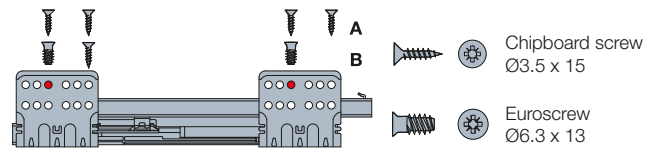

A trial mounting is always recommended. For further information please contact Titus Tekform. Download supporting documentation from the Titus Tekform website [titustekform.com.au](http://titustekform.com.au)

# Tekform Slimline Drawer DW182

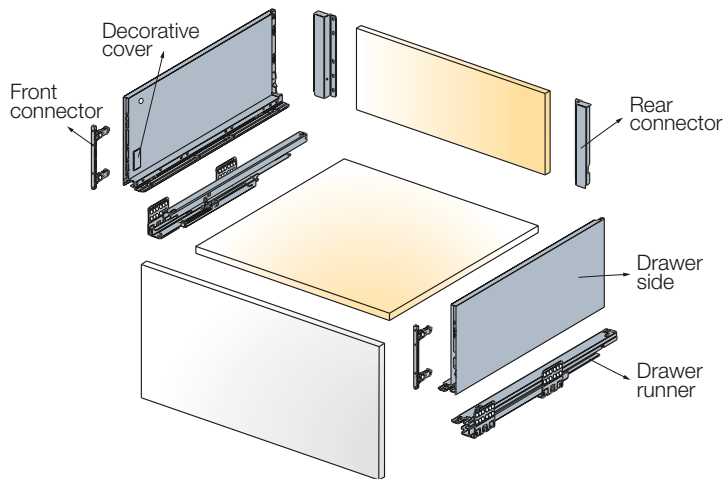
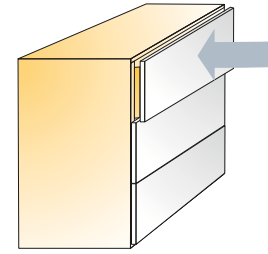

### Cutting dimensions details

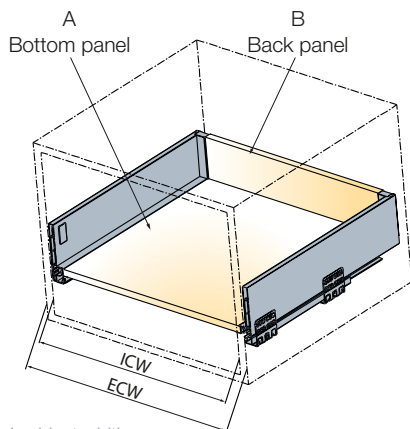



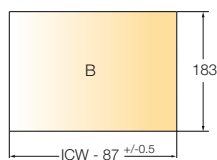
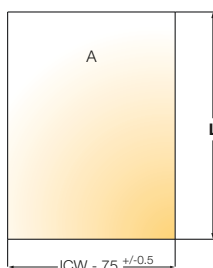



ECW: External cabinet width  
ICW: Internal cabinet width  
NL: Nominal length of drawer



$L = NL - 10$

For further explanation → see page 9

Nominal length (mm)	with EasyFix front connector	with Screw-in front connector	Color	
	Item number for a set	Item number for a set	White	Anthracite grey
270	655.8Z27 →	655.8H27 →	150.00	185.00
300*	655.8Z30 →	655.8H30 →	150.00	185.00
350	655.8Z35 →	655.8H35 →	150.00	185.00
400	655.8Z40 →	655.8H40 →	150.00	185.00
450	655.8Z45 →	655.8H45 →	150.00	185.00
500	655.8Z50 →	655.8H50 →	150.00	185.00
550	655.8Z55 →	655.8H55 →	150.00	185.00
<b>One set consists of</b>				
	Drawer sides		2 pcs	
	Drawer runners		2 pcs	
	^Front connectors		2 pcs	
	Rear connectors		2 pcs	
	Covers		2 pcs	
	Mounting instructions		1 pce	

Screws not included. ^Front connectors determined by order code.

- Drawer runner type
- Load capacity
- Minimum height per drawer required
- Wooden back panel thickness
- Wooden bottom panel thickness

Full extension  
40kg  
230mm  
16mm  
16mm

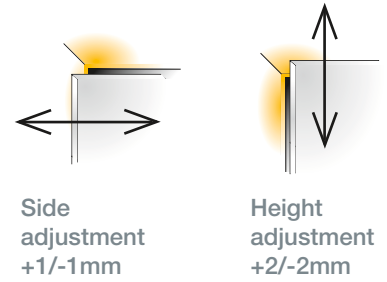

For further explanation → see page 11

Installation dimensions

Drawer runner fixing positions

Minimum space required for the cabinet

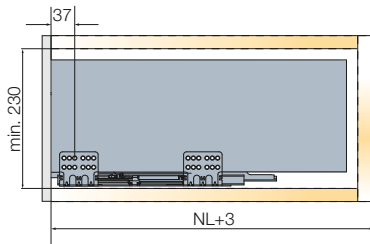

Drilling dimensions for the front panel

EasyFix attachment

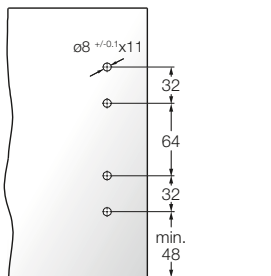

Screw-in attachment

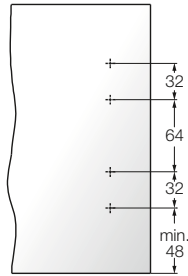

Mounting dimensions for the back panel

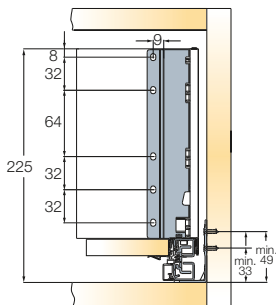

Installation dimensions for the front panel

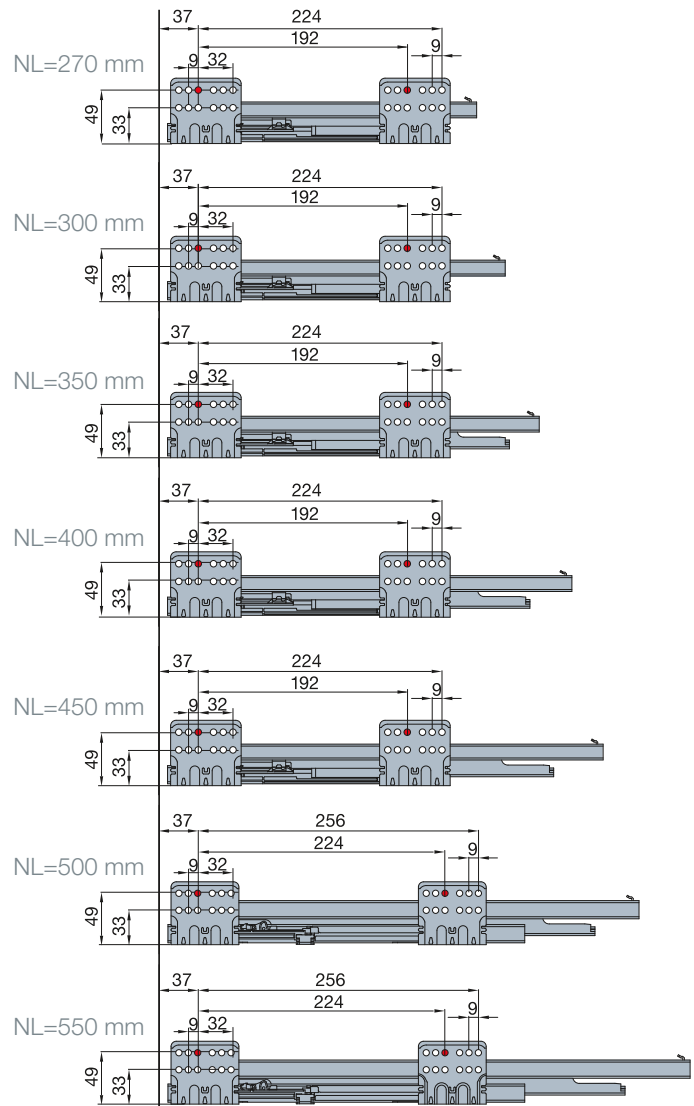
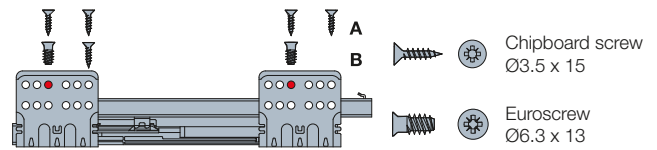
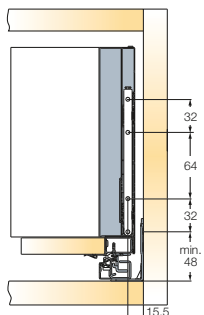

A trial mounting is always recommended. For further information please contact Titus Tekform. Download supporting documentation from the Titus Tekform website [titustekform.com.au](http://titustekform.com.au)

# Inner Drawer Front for Tekform Slimline Drawer DW70

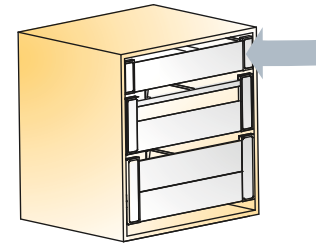

Inner drawer front, assembly set

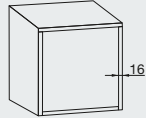

Made of aluminium and plastic

External cabinet width (mm)	Cabinet side thickness=16mm	Color	
		White	Anthracite grey
			
	Item number		
400	655.8177 →	511.00	515.00
450	655.8178 →	511.00	515.00
500	655.8179 →	511.00	515.00
600	655.8180 →	511.00	515.00
800	655.8181 →	511.00	515.00
900	655.8182 →	511.00	515.00
1000	655.8183 →	511.00	515.00
1200	655.8184 →	511.00	515.00

Front panel

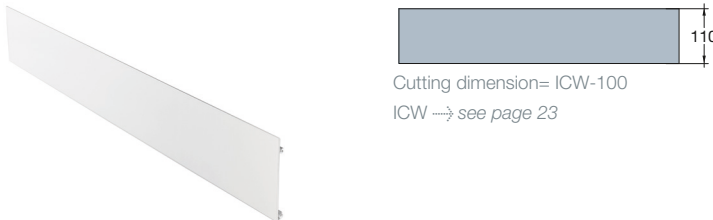

Made of aluminium

600	655.8185 →	511.00	515.00
800	655.8186 →	511.00	515.00
900	655.8187 →	511.00	515.00
1000	655.8188 →	511.00	515.00
1200	655.8189 →	511.00	515.00

Front bracket



Made of aluminium and plastic

	655.8065 →	150.00	185.00
--	------------	--------	--------



Bottom panel support

650.8908.350 white  
650.8908.385 grey

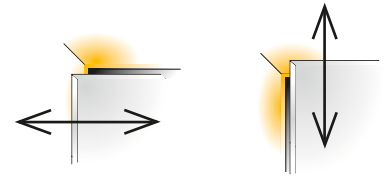
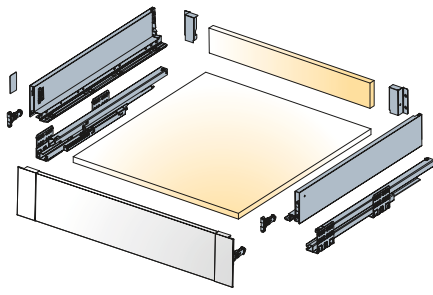

Side adjustment  
+1/-1mm

Height adjustment  
+2/-2mm

For further explanation → see page 11-12

Installation dimensions

Drawer runner fixing positions

Minimum space required for the cabinet

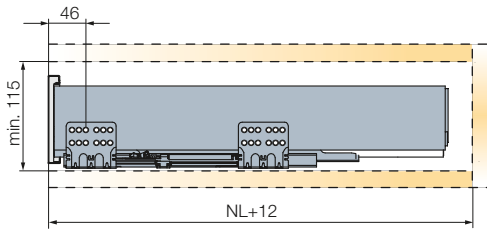

Cutting dimensions details

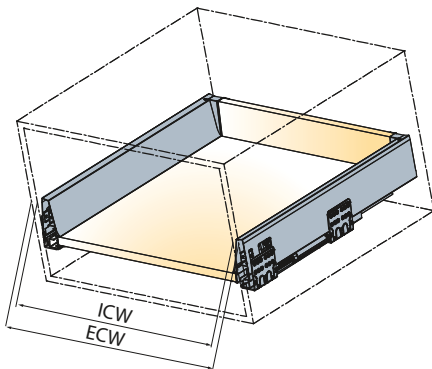

ECW: External cabinet width  
ICW: Internal cabinet width  
NL: Nominal length of drawer

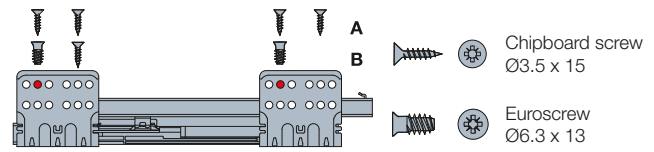

⚠ Use the second hole for runner fixing.

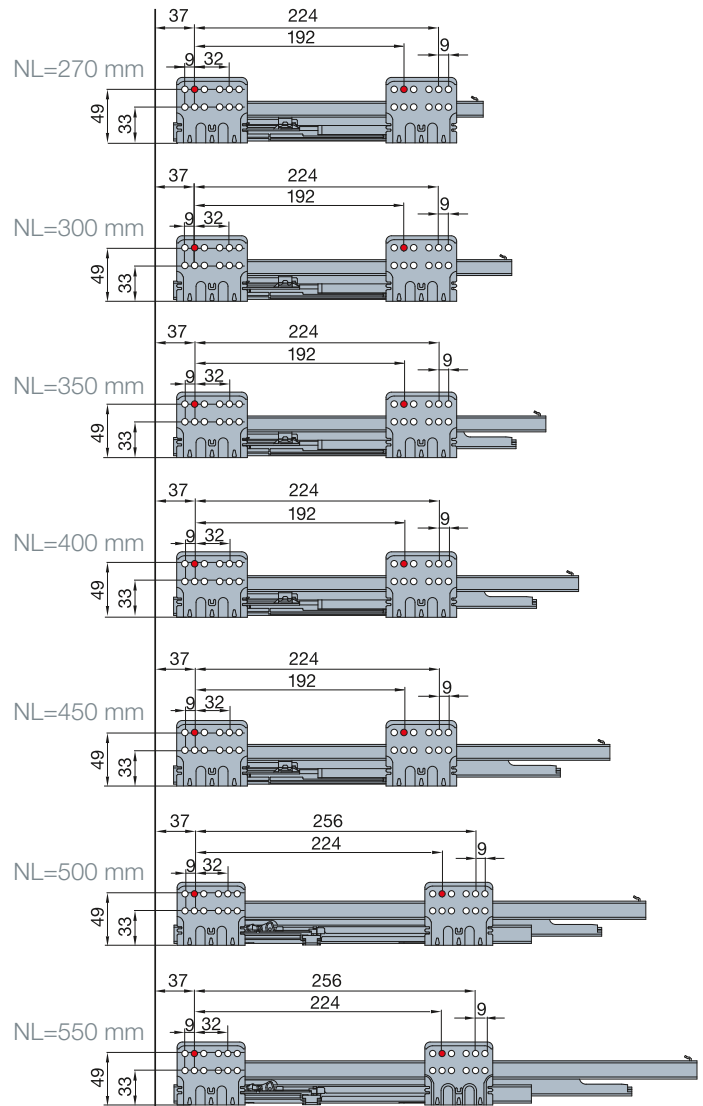

# Inner Drawer Front for Tekform Slimline Drawer DW70 with Glass

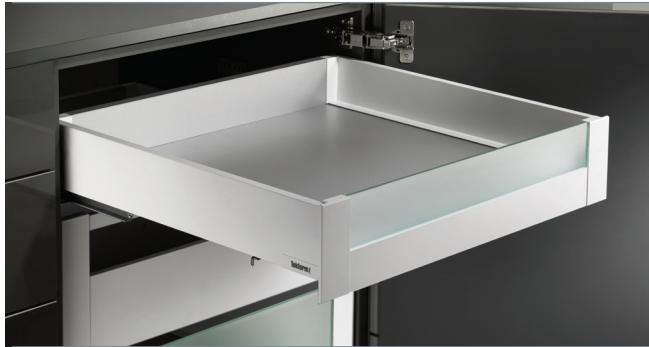
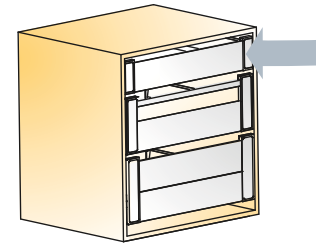

Inner drawer front, assembly set

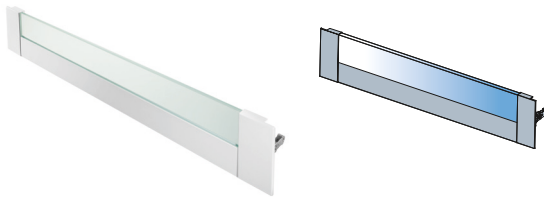

Made of aluminium and glass

Front panel

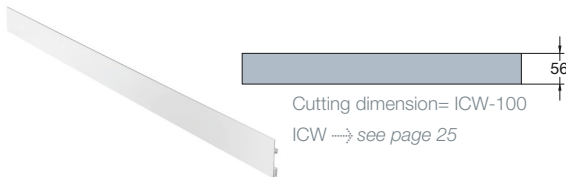

Made of aluminium

Low glass

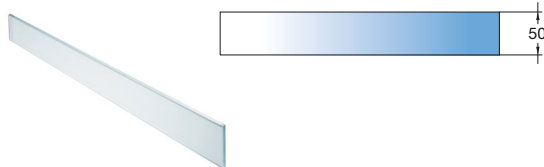

Made of glass

Front bracket



Made of aluminium and plastic

External cabinet width (mm)	Cabinet side thickness=16mm	Material options			
		White	Anthracite grey	Frosted glass	Transparent glass
	Item number				
400	655.8306 →	511.00	515.00		
450	655.8307 →	511.00	515.00		
500	655.8308 →	511.00	515.00		
600	655.8285 →	511.00	515.00		
800	655.8286 →	511.00	515.00		
900	655.8287 →	511.00	515.00		
1000	655.8288 →	511.00	515.00		
1200	655.8289 →	511.00	515.00		
600	655.8205 →	511.00	515.00		
800	655.8206 →	511.00	515.00		
900	655.8207 →	511.00	515.00		
1000	655.8208 →	511.00	515.00		
1200	655.8209 →	511.00	515.00		
600	655.8295 →			391.00	392.00
800	655.8296 →			391.00	392.00
900	655.8297 →			391.00	392.00
1000	655.8298 →			391.00	392.00
1200	655.8299 →			391.00	392.00
	655.8305 →	150.00	185.00		



Bottom panel support

650.8908.350 white  
650.8908.385 grey



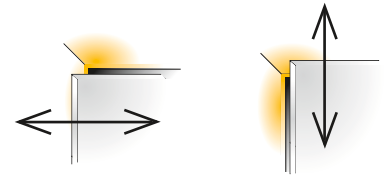
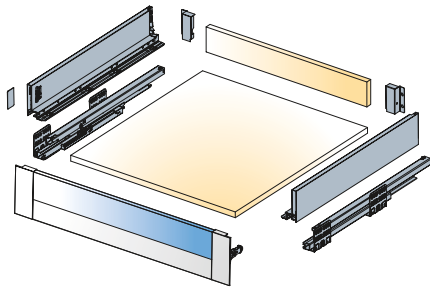

Side adjustment  
+1/-1mm

Height adjustment  
+2/-2mm

For further explanation → see page 11-12

Installation dimensions

Drawer runner fixing positions

Minimum space required for the cabinet

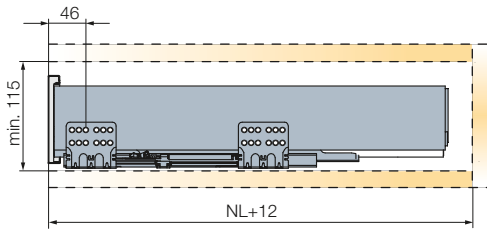

Cutting dimensions details

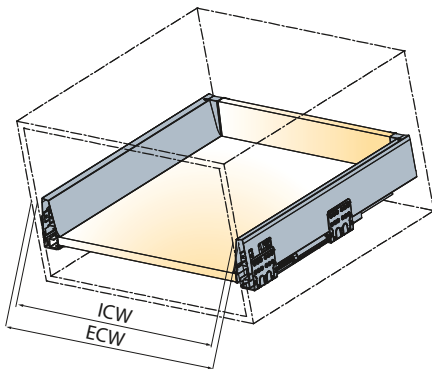

ECW: External cabinet width  
ICW: Internal cabinet width  
NL: Nominal length of drawer

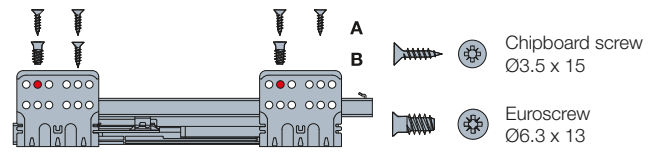

⚠ Use the second hole for runner fixing.

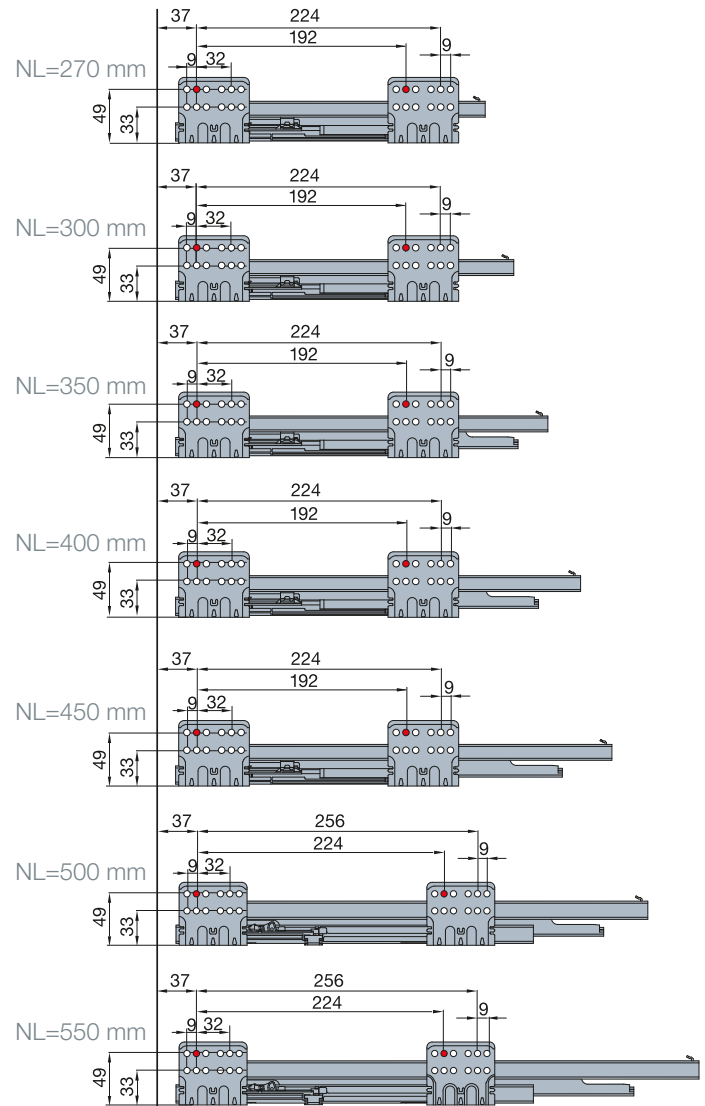

# Inner Drawer Front for Tekform Slimline Drawer DW145 with Bar

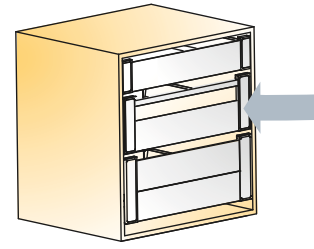

Inner drawer front, assembly set

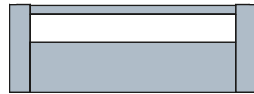

Made of aluminium and plastic

Front bar



Cutting dimension= ICW-88  
ICW → see page 27

Made of aluminium

Front panel



Cutting dimension= ICW-100  
ICW → see page 27

Made of aluminium

Front bracket



Made of aluminium and plastic

External cabinet width (mm)	Cabinet side thickness=16mm			
	Item number		White	Anthracite grey
400	655.8309 →		511.00	515.00
450	655.8310 →		511.00	515.00
500	655.8311 →		511.00	515.00
600	655.8190 →		511.00	515.00
800	655.8191 →		511.00	515.00
900	655.8192 →		511.00	515.00
1000	655.8193 →		511.00	515.00
1200	655.8194 →		511.00	515.00
600	655.8210 →		511.00	515.00
800	655.8211 →		511.00	515.00
900	655.8212 →		511.00	515.00
1000	655.8213 →		511.00	515.00
1200	655.8214 →		511.00	515.00
600	655.8185 →		511.00	515.00
800	655.8186 →		511.00	515.00
900	655.8187 →		511.00	515.00
1000	655.8188 →		511.00	515.00
1200	655.8189 →		511.00	515.00
	655.8101 →		350.00	385.00



**Bottom panel support**  
650.8908.350 white  
650.8908.385 grey

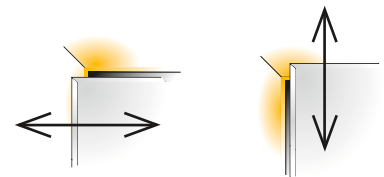
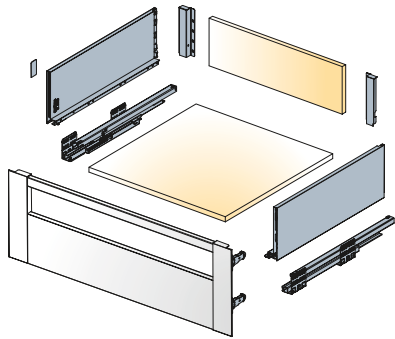

Side adjustment  
+1/-1mm

Height adjustment  
+2/-2mm

For further explanation → see page 11-12

Installation dimensions

Drawer runner fixing positions

Minimum space required for the cabinet

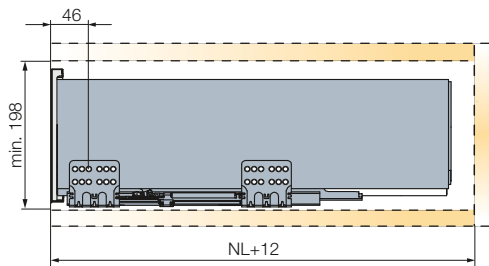

Cutting dimensions details

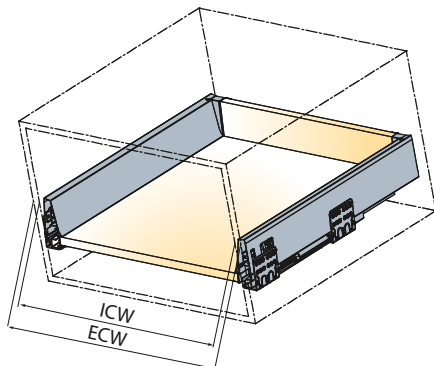

ECW: External cabinet width  
ICW: Internal cabinet width  
NL: Nominal length of drawer

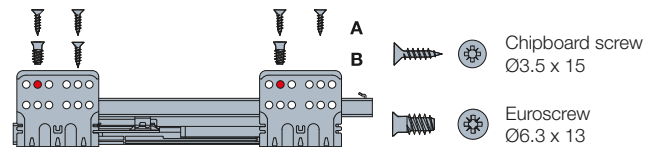

⚠ Use the second hole for runner fixing.

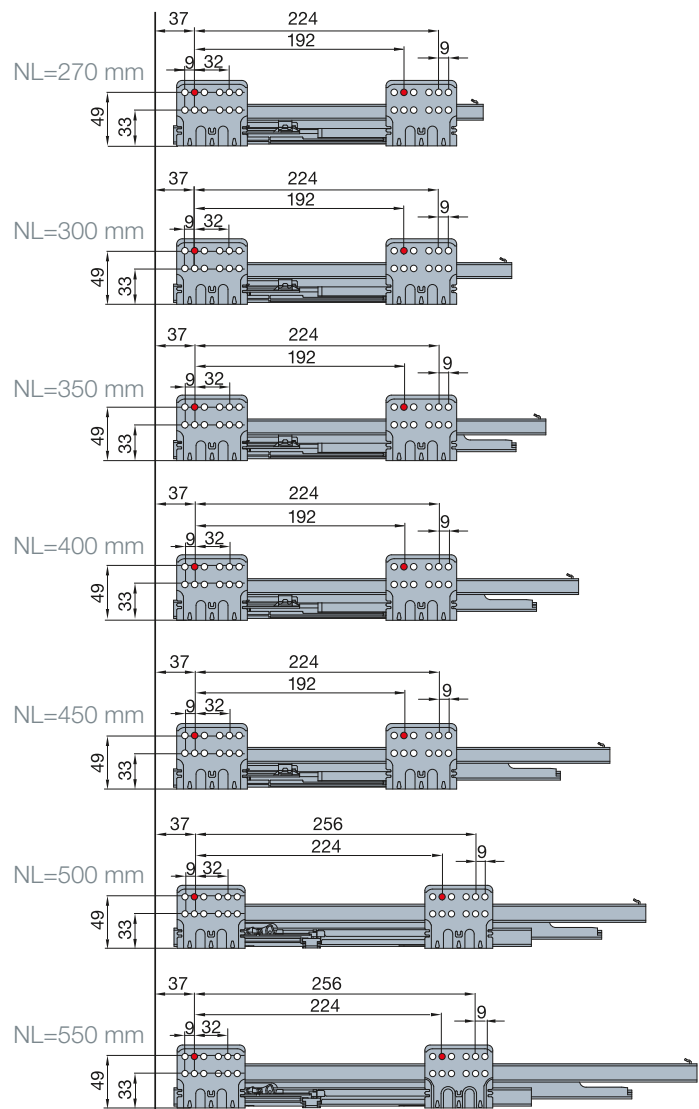

# Inner Drawer Front for Tekform Slimline Drawer DW145 with Glass

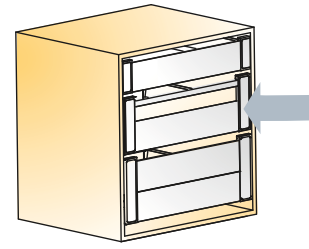

Inner drawer front, assembly set

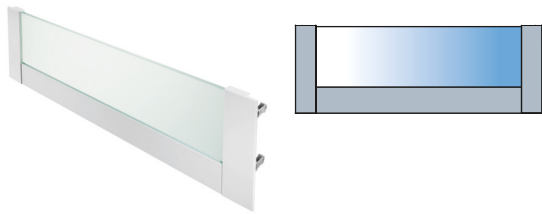

Made of aluminium and glass

Front panel

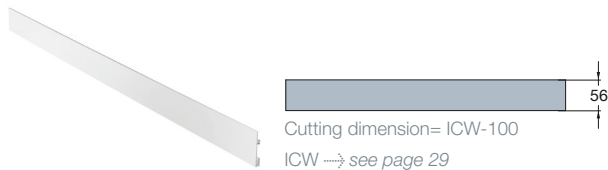

Made of aluminium

Front glass panel - high

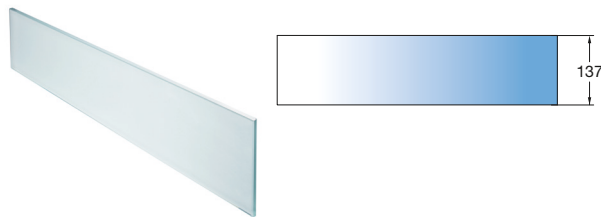

Made of glass

Front bracket

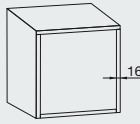

Made of aluminium and plastic

External cabinet width (mm)	Cabinet side thickness=16mm 	Glass options			
		White	Anthraxite grey	Frosted glass	Transparent glass
Item number					
400	655.8312 →	511.00	515.00		
450	655.8313 →	511.00	515.00		
500	655.8314 →	511.00	515.00		
600	655.8200 →	511.00	515.00		
800	655.8201 →	511.00	515.00		
900	655.8202 →	511.00	515.00		
1000	655.8203 →	511.00	515.00		
1200	655.8204 →	511.00	515.00		
600	655.8205 →	511.00	515.00		
800	655.8206 →	511.00	515.00		
900	655.8207 →	511.00	515.00		
1000	655.8208 →	511.00	515.00		
1200	655.8209 →	511.00	515.00		
600	655.8220 →			391.00	392.00
800	655.8221 →			391.00	392.00
900	655.8222 →			391.00	392.00
1000	655.8223 →			391.00	392.00
1200	655.8224 →			391.00	392.00
	655.8103 →	350.00	385.00		



**Bottom panel support**  
650.8908.350 white  
650.8908.385 grey

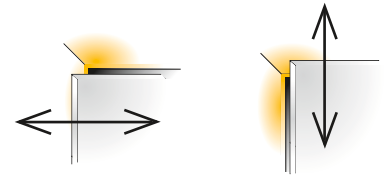
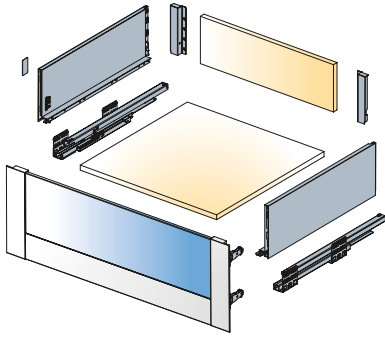

Side adjustment  
+1/-1mm

Height adjustment  
+2/-2mm

For further explanation → see page 11-12

Installation dimensions

Drawer runner fixing positions

Minimum space required for the cabinet

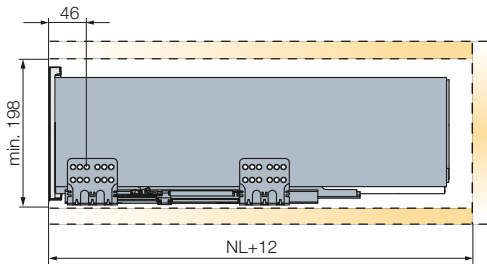

Cutting dimensions details

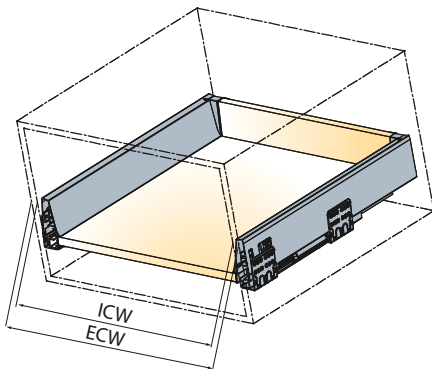

ECW: External cabinet width  
ICW: Internal cabinet width  
NL: Nominal length of drawer

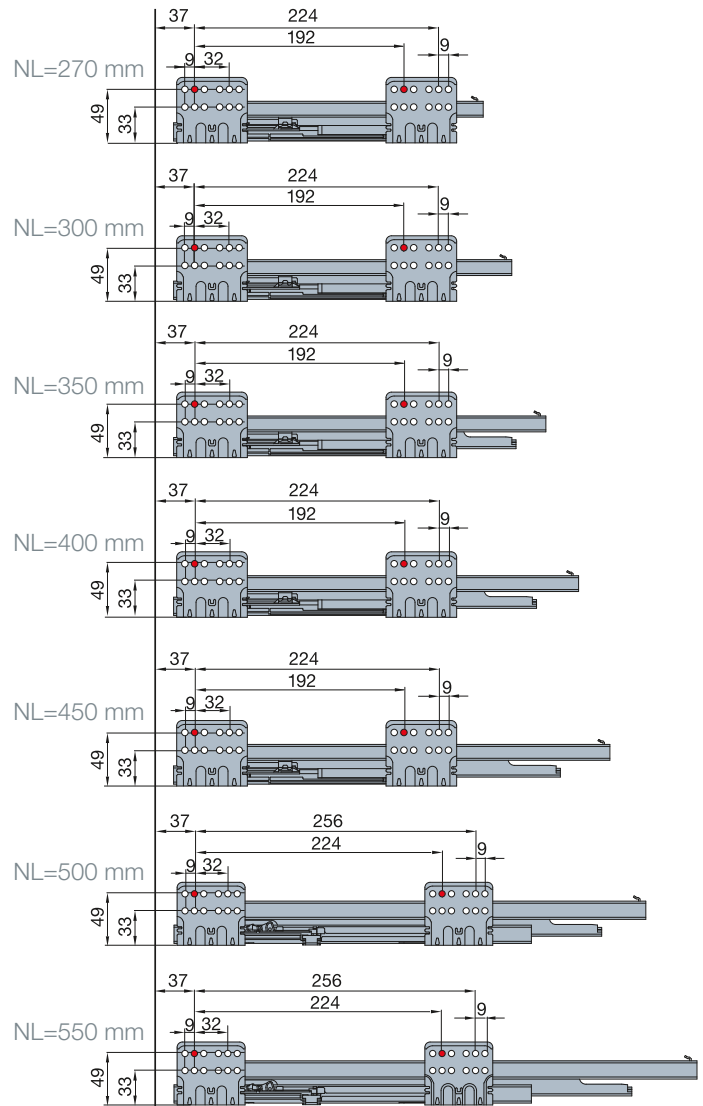
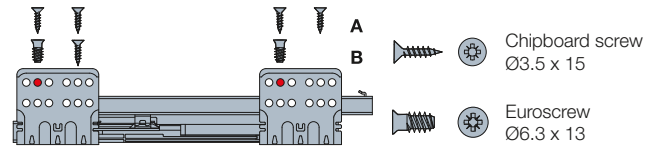

# Inner Drawer Front for Tekform Slimline Drawer DW182 with Bar

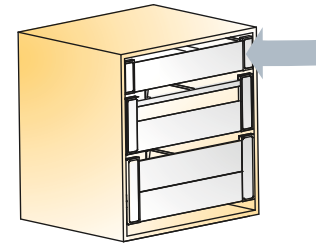

Inner drawer front, assembly set

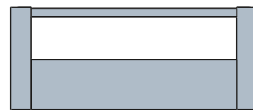

Made of aluminium and plastic

Front bar



Cutting dimension= ICW-88  
ICW → see page 31

Made of aluminium

Front panel



Cutting dimension= ICW-100  
ICW → see page 31

Made of aluminium

Front bracket



Made of aluminium and plastic

External cabinet width (mm)	Item number	Cabinet side thickness=16mm	
		White	Anthracite grey
400	655.8315 →	511.00	515.00
450	655.8316 →	511.00	515.00
500	655.8317 →	511.00	515.00
600	655.8260 →	511.00	515.00
800	655.8261 →	511.00	515.00
900	655.8262 →	511.00	515.00
1000	655.8263 →	511.00	515.00
1200	655.8264 →	511.00	515.00
600	655.8210 →	511.00	515.00
800	655.8211 →	511.00	515.00
900	655.8212 →	511.00	515.00
1000	655.8213 →	511.00	515.00
1200	655.8214 →	511.00	515.00
600	655.8185 →	511.00	515.00
800	655.8186 →	511.00	515.00
900	655.8187 →	511.00	515.00
1000	655.8188 →	511.00	515.00
1200	655.8189 →	511.00	515.00
	655.8170 →	350.00	385.00



Bottom panel support

650.8908.350 white  
650.8908.385 grey

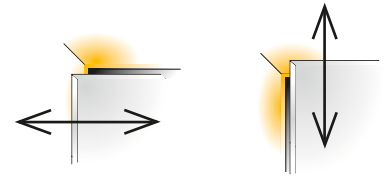
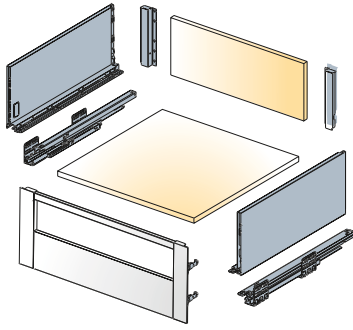

Side adjustment  
+1/-1mm

Height adjustment  
+2/-2mm

For further explanation → see page 11-12

Installation dimensions

Drawer runner fixing positions

Minimum space required for the cabinet

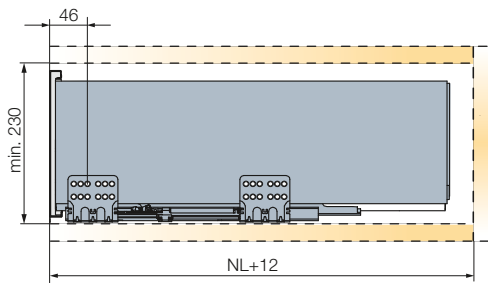

Cutting dimensions details

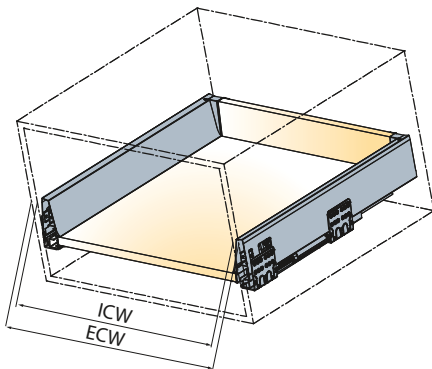

ECW: External cabinet width  
ICW: Internal cabinet width  
NL: Nominal length of drawer

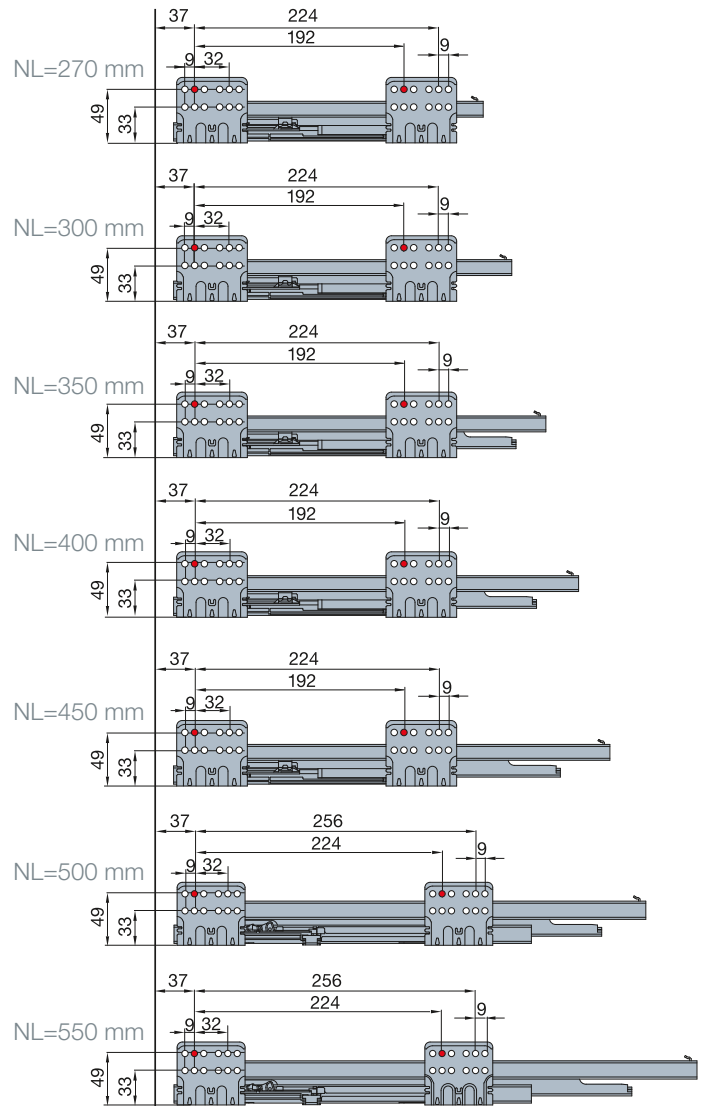
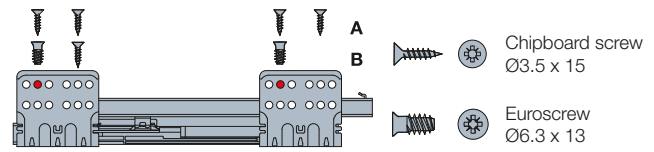

# Inner Drawer Front for Tekform Slimline Drawer DW182 with Glass

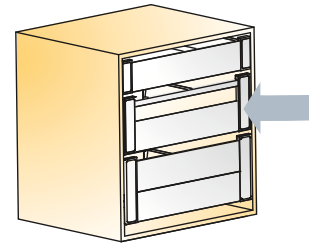

Inner drawer front, assembly set

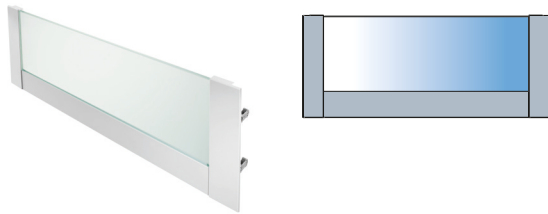

Made of aluminium and glass

Front panel

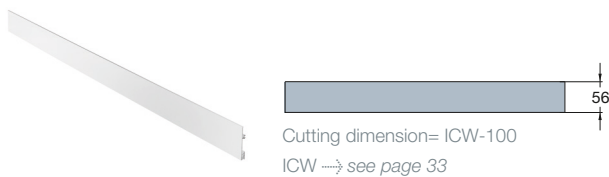

Made of aluminium

Front glass panel - high

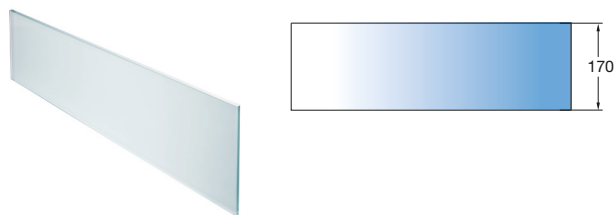

Made of glass

Front bracket

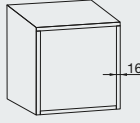

Made of aluminium and plastic

External cabinet width (mm)	Cabinet side thickness=16mm 	Cabinet side thickness=16mm			
		White	Anthracite grey	Frosted glass	Transparent glass
Item number					
400	655.8321 →	511.00	515.00		
450	655.8322 →	511.00	515.00		
500	655.8323 →	511.00	515.00		
600	655.8270 →	511.00	515.00		
800	655.8271 →	511.00	515.00		
900	655.8272 →	511.00	515.00		
1000	655.8273 →	511.00	515.00		
1200	655.8274 →	511.00	515.00		
600	655.8205 →	511.00	515.00		
800	655.8206 →	511.00	515.00		
900	655.8207 →	511.00	515.00		
1000	655.8208 →	511.00	515.00		
1200	655.8209 →	511.00	515.00		
600	655.8280 →			391.00	392.00
800	655.8281 →			391.00	392.00
900	655.8282 →			391.00	392.00
1000	655.8283 →			391.00	392.00
1200	655.8284 →			391.00	392.00
	655.8172 →	350.00	385.00		



Bottom panel support

650.8908.350 white  
650.8908.385 grey



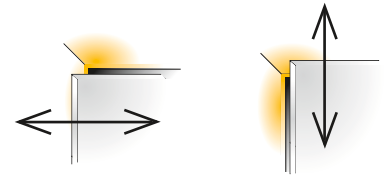
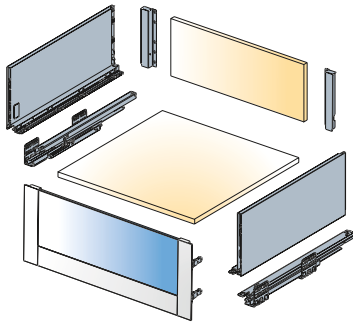

Side adjustment  
+1/-1mm

Height adjustment  
+2/-2mm

For further explanation → see page 11-12

Installation dimensions

Drawer runner fixing positions

Minimum space required for the cabinet

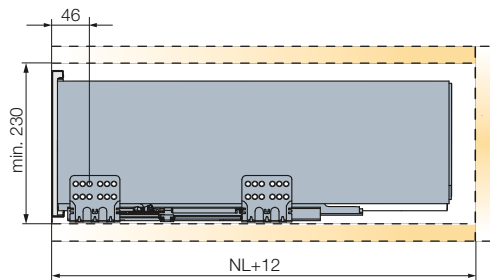

Cutting dimensions details

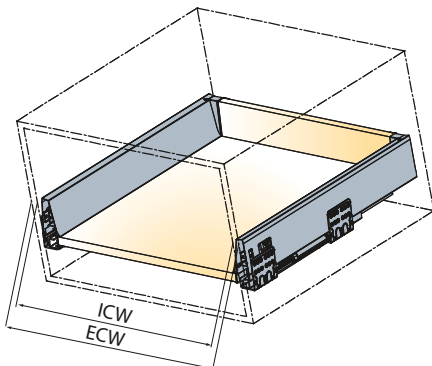

ECW: External cabinet width  
ICW: Internal cabinet width  
NL: Nominal length of drawer

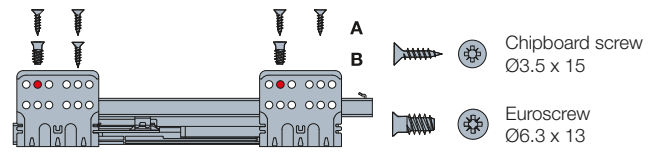

⚠ Use the second hole for runner fixing.

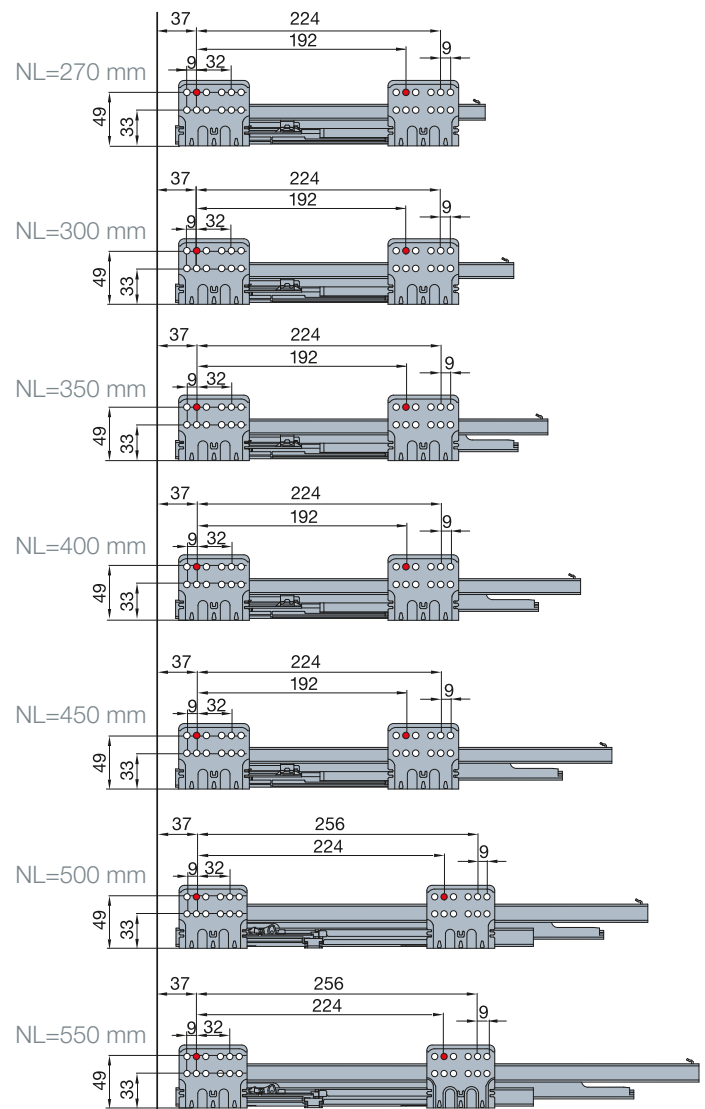

# Assembly Instructions

 Screws are not included

## Assembly Sequence

Connect the drawer sides to the bottom panel (1) and fix it with screws (2)

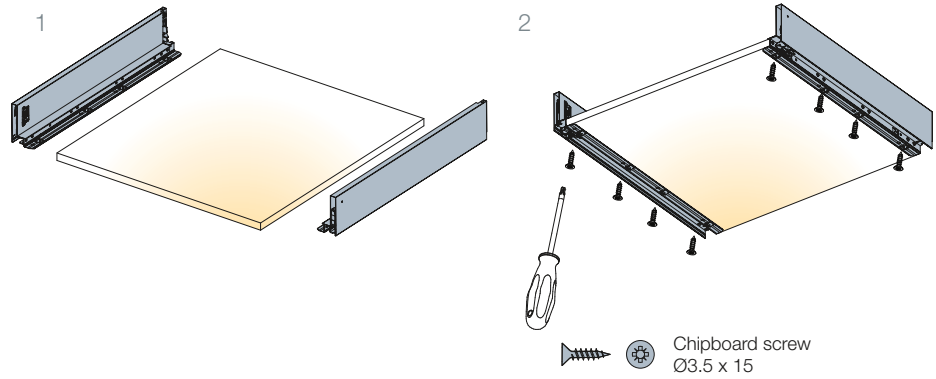

Insert the rear connector vertically (3) and push it downwards into recess in the drawer side (4)

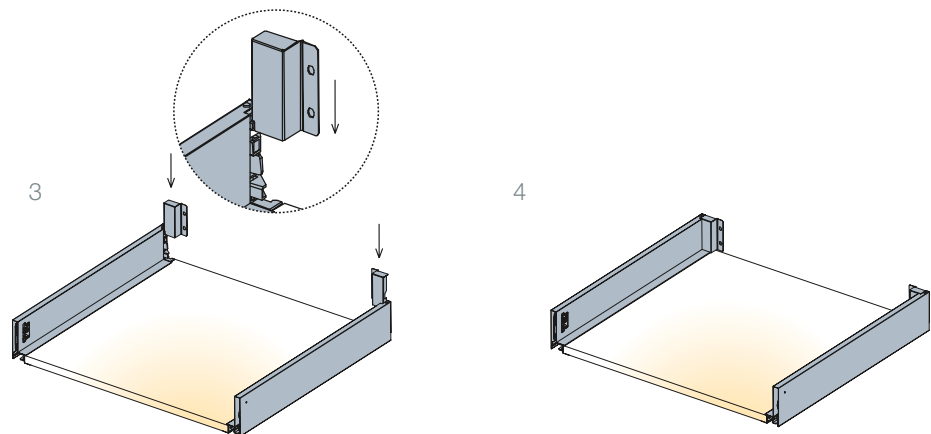

Insert the back panel (5) and fix it with screws (6)

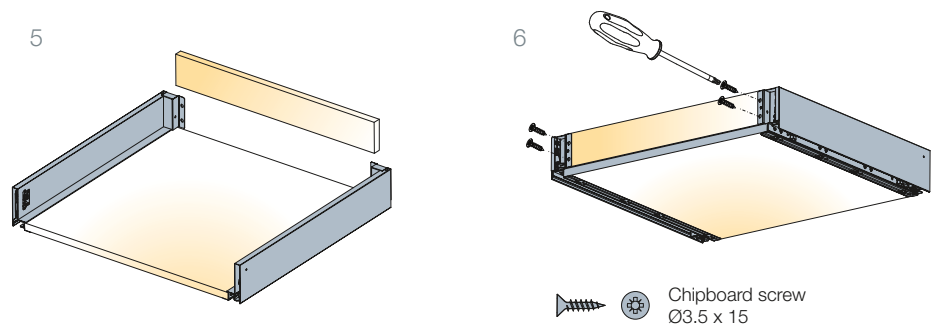

 Screws are not included

## Insertion of Front Connectors

### EasyFix

Insert the front connectors into holes on the front panel

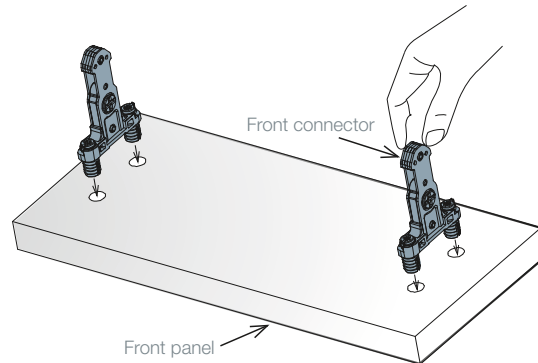

Turn the screws 90° into locked position

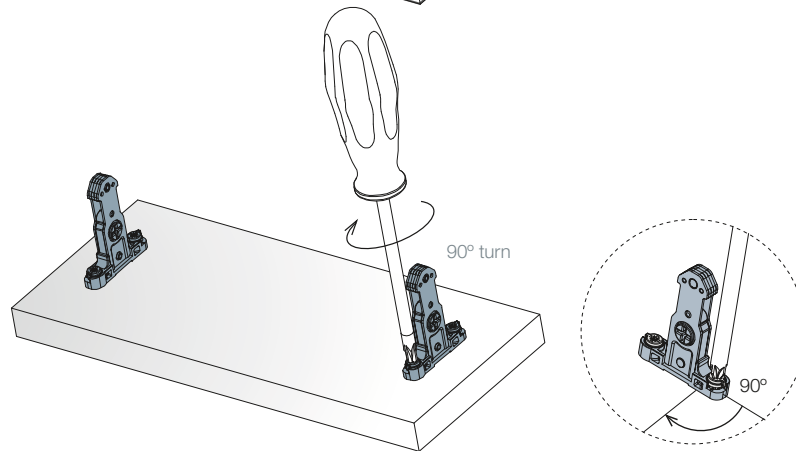

### Screw-in fixing

Use Ø3 x 15mm screws for fixing

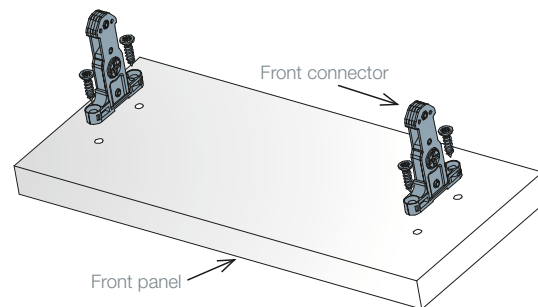

 Chipboard screw  
Ø3.5 x 15

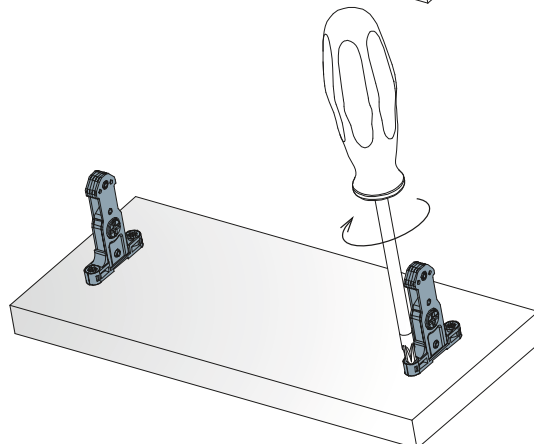

# Assembly Instructions

## Front Panel Mounting / Removal

### Mounting

Attach the front panel to the drawer and press to click

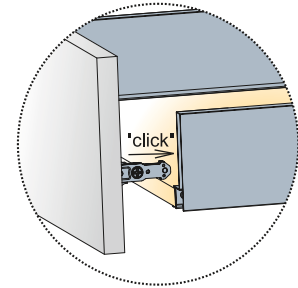
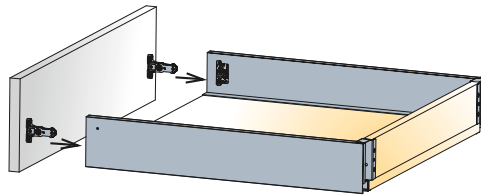

### Removal

Turn the screw towards the front panel

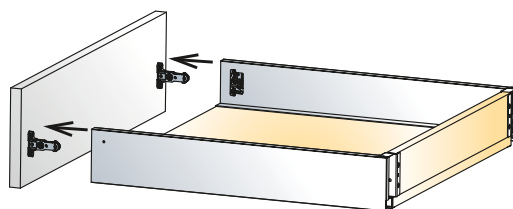
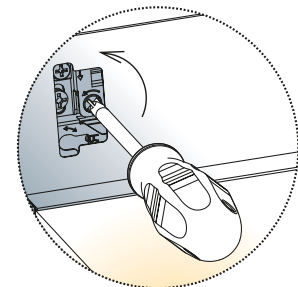
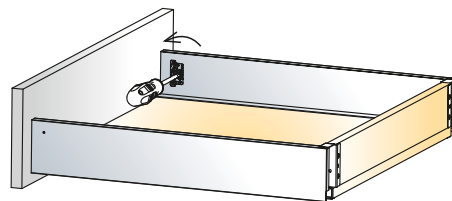

## Drawer Insertion / Removal

### Insertion

Place the drawer horizontally on the runners and push towards the cabinet until you hear the drawer is locked

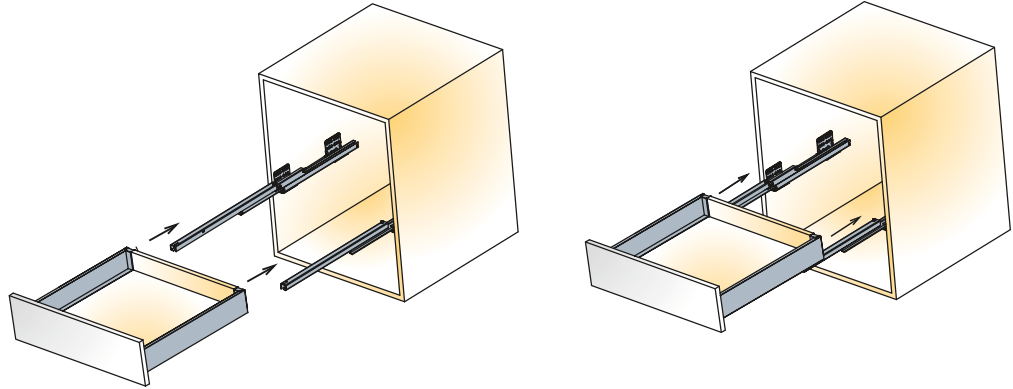

Push to fully close

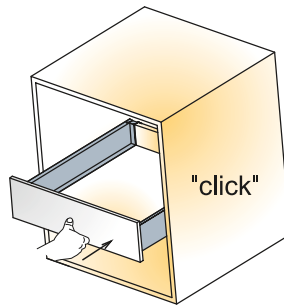

### Removal

Press-up the button under the drawer. Keep pressed to pull the drawer out

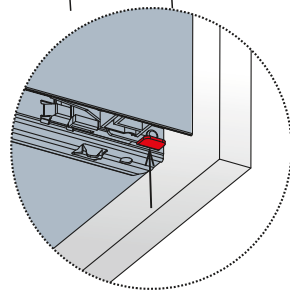
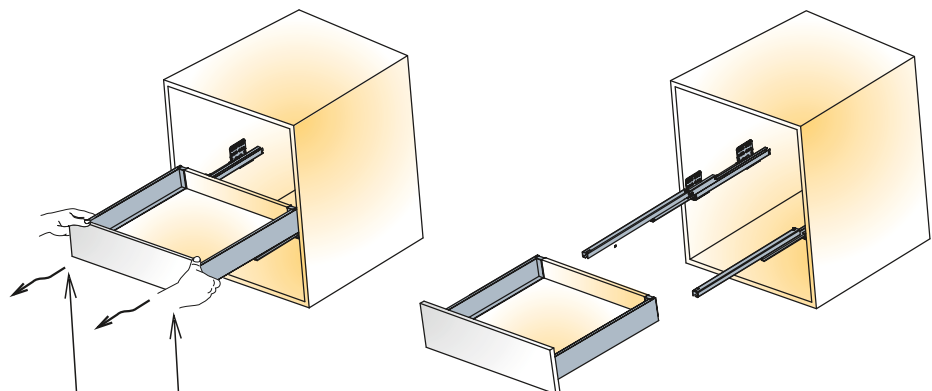

Press-up

# Accessories Mounting

## Assembly of Inner Drawer Front

Slimline DW70

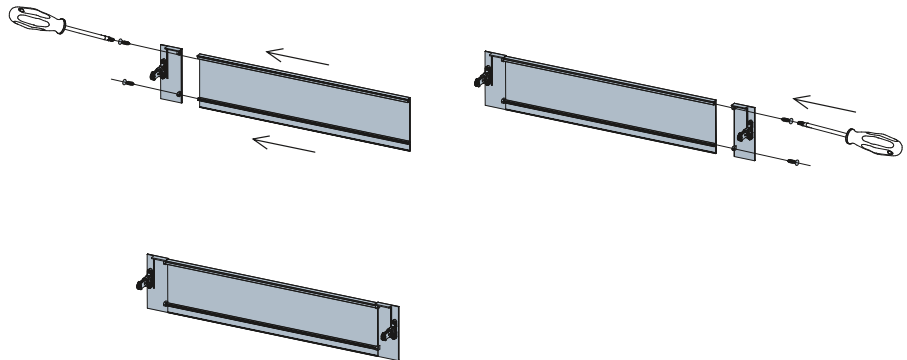

Slimline DW145 and DW182  
with bar

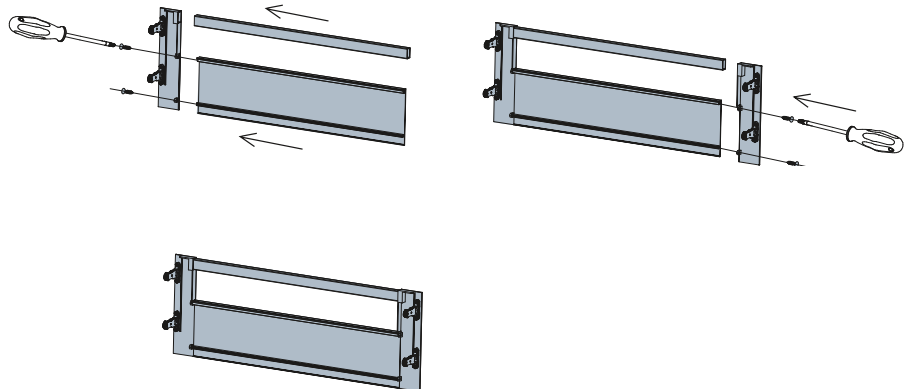

Slimline DW70, DW145 and  
DW182 with glass

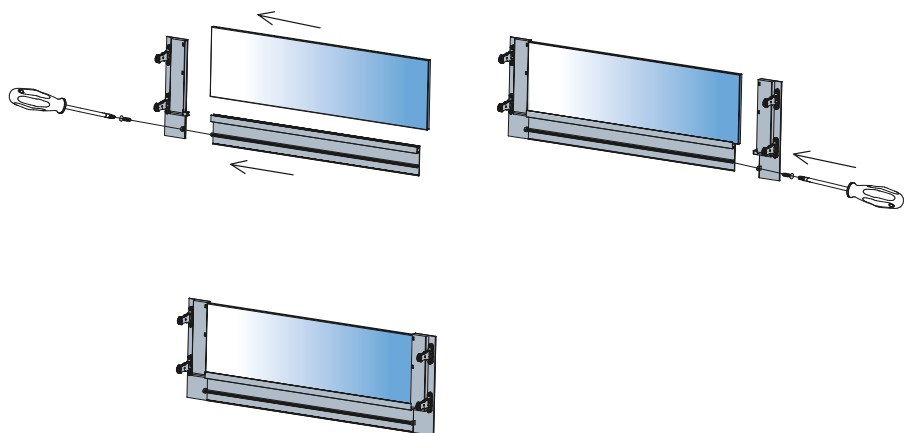







# The Titus Group Profile

# Titus Group

Titus focuses on the design, manufacture and distribution of connectors, concealed hinges drawers and soft closing mechanisms in furniture and household appliances.

Titus Group is owned and managed from its headquarters in United Kingdom. We are able to provide products and services to every customer around the world based on manufacturing facilities in Europe, North America, China, SE Asia, Australia and New Zealand.

**Quickfit technology makes Titus the World leader in connectors for RTA furniture**

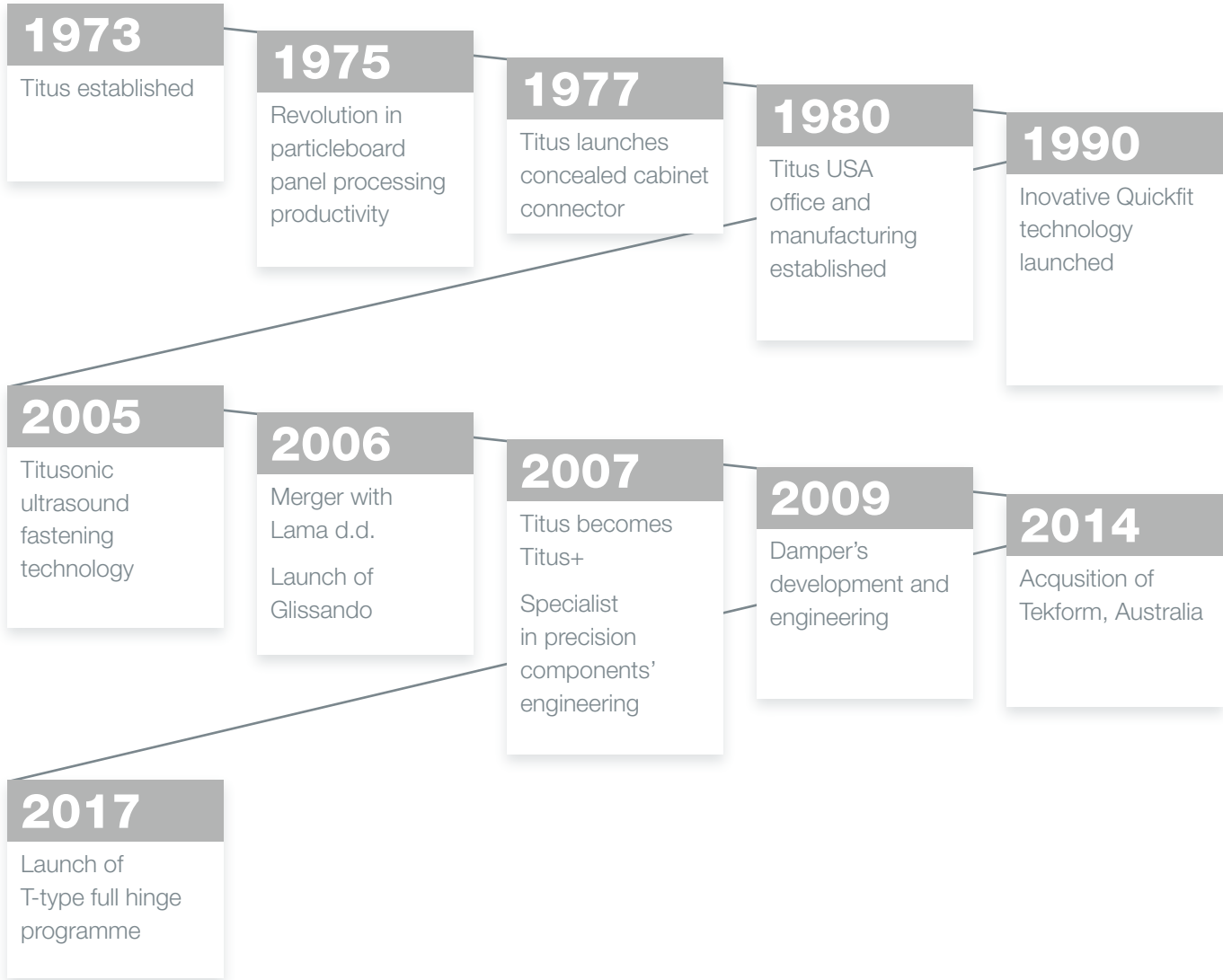

## Vision

The world's best engineering for precision components

## Mission

To provide manufacturers with components' solutions that improve competitiveness

## Titus Business Philosophies and Principles

- Gain total knowledge of our customers and their markets
- Focus on identifying and creating high volume component niches
- Meet our customers' expectations with global consistency
- Build long term associations with customers, suppliers, colleagues and shareholders
- Invest in the abilities of individuals at every level
- Continuously enhance input efficiency and sustainability

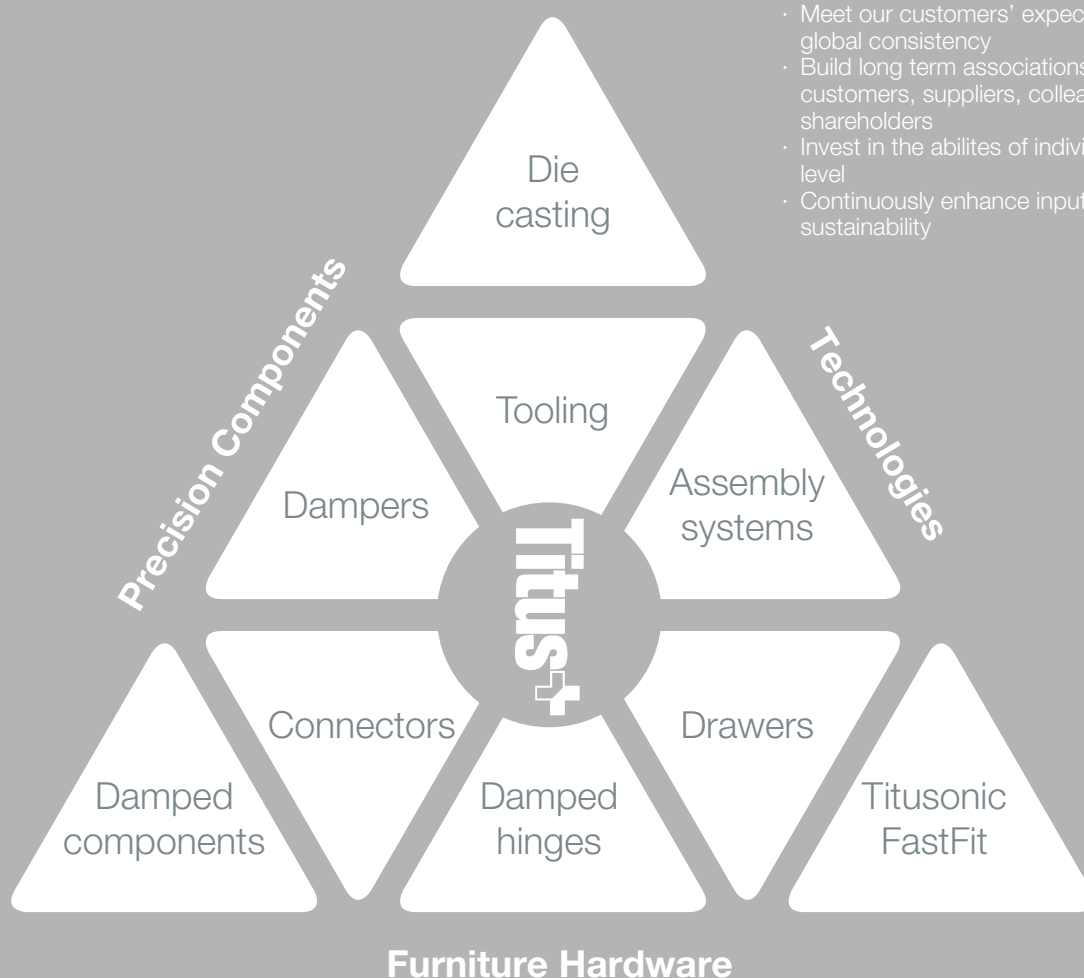

## Furniture Hardware

- Cabinet connectors
- Concealed hinges
- Soft closing systems
- Drawers and drawer systems
- Kitchen accessories
- Furniture locks
- Decorative

## Components

- Dampers
- Precision components

## Technologies

- Automation systems
- Precision castings
- Die cast technologies
- Tooling
- Ultrasound fastening technology
- FastFit technology

# 'Totally Integrated Engineering'

## Product Design

Design and engineering of unique components  
Consistent and repeatable product quality

## Manufacturing Technologies

To improve productivity and product quality

## Manufacturing Operations

A wide array of technologies and services required for high volume production of precision components available in-house

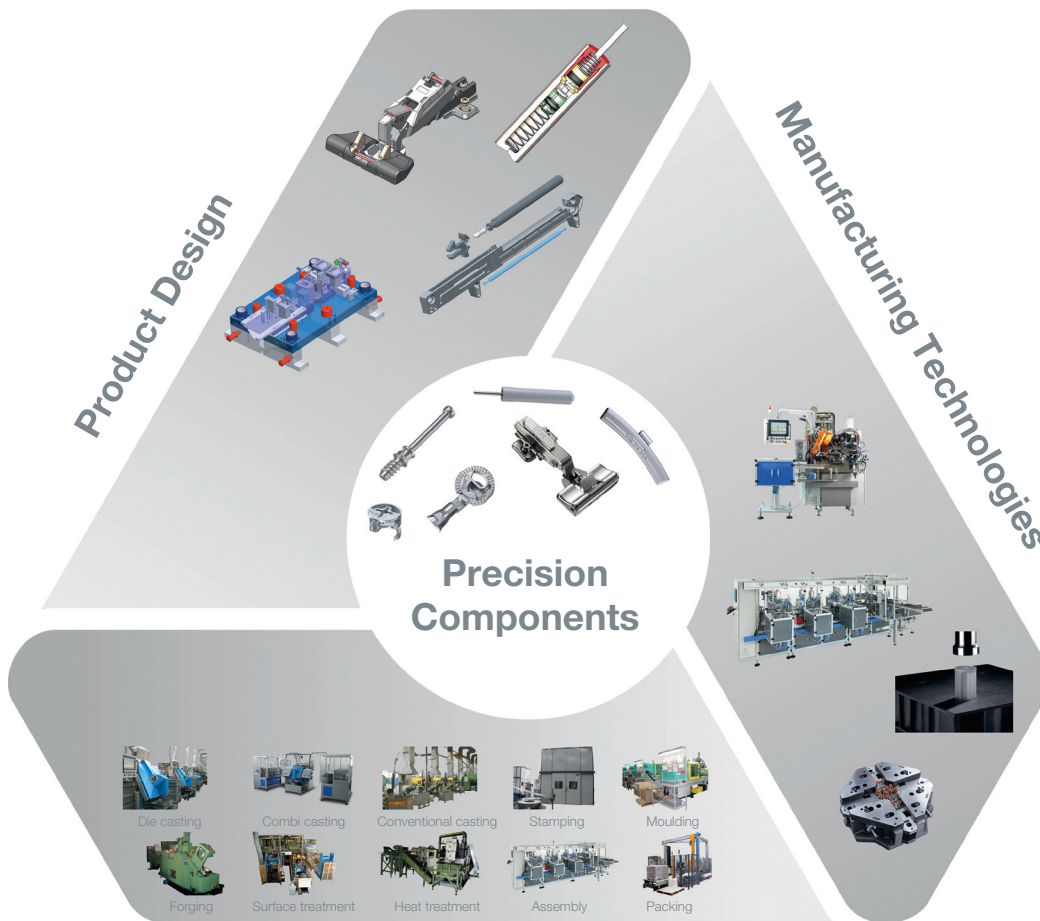

## Manufacturing Operations

### Fittings for purpose

Unique product advantages for better value for money and lower 'total installed cost'

### Innovations that improve

With less parts, less different parts, less preparation actions, faster assembly

### Fast time-to-market

# Quality

## Continuous Improvement

The Titus Group Mission, to improve the competitiveness of our customers, encourages us to continuously improve our products, services, processes and competencies of our employees.

## Quality

We believe that the Titus Mission is achieved most effectively through the management of our design, manufacturing and service activities in conformance with the ISO 9001 standard for quality management. Quality has a broad meaning for us: it is our guide to the selection of materials, work, processes, internal relations and cooperation with partners.

## Products

Our integrated quality system produces technically optimized products of high quality. They are assessed regularly in our own test labs as well as by internationally renowned institutions, such as LGA from Germany, CTBA from France, FIRA from United Kingdom, CATAS from Italy, AIDIMA from Spain, and others.

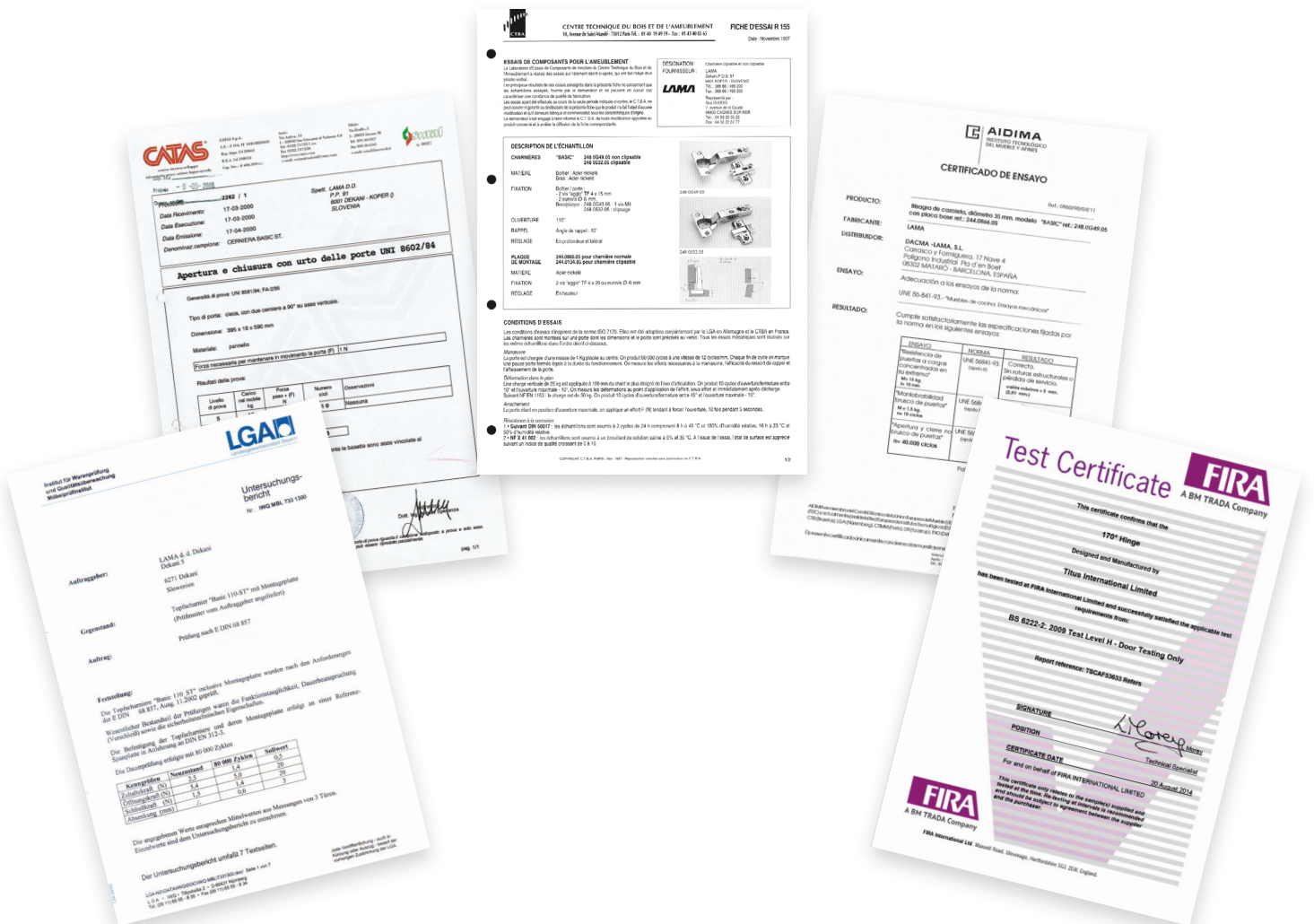



# Global player

## Worldwide design, manufacturing and distribution capabilities

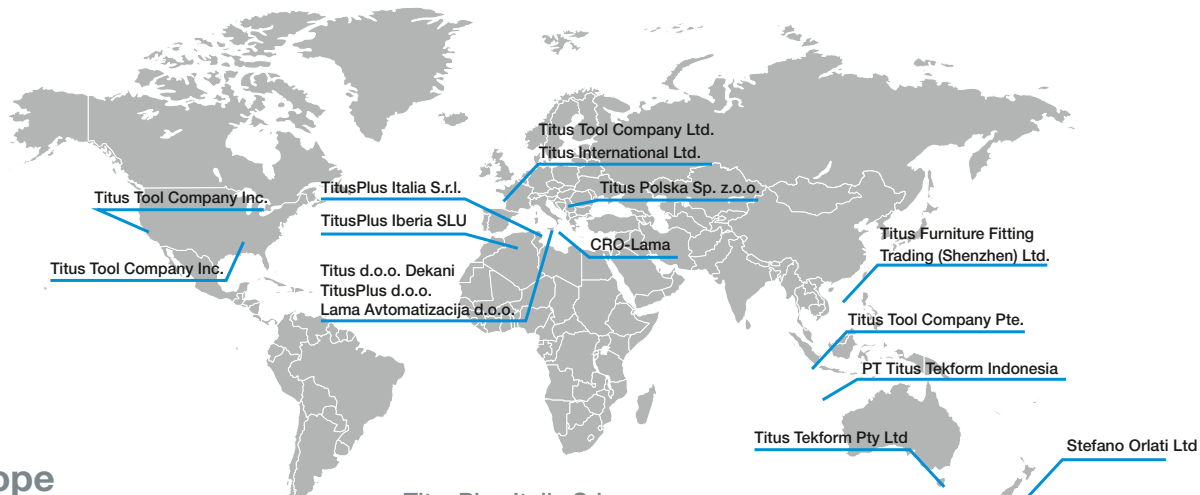

### Europe

**TitusPlus d.o.o.**  
 Dekani 5  
 SI-6271 Dekani  
 Slovenia  
 +386 566 90 213  
 +386 566 90 205 Fax  
 info@titusplus.com

**Titus d.o.o. Dekani**  
 Dekani 5  
 SI-6271 Dekani  
 Slovenia  
 +386 566 90 213  
 +386 566 90 205 Fax  
 info@titusplus.com

**Titus Technologies**  
**Lama Avtomatizacija d.o.o.**  
 Dekani 5  
 SI-6271 Dekani  
 Slovenia  
 +386 566 90 432  
 +386 566 90 431 Fax  
 titustechnologies@titusplus.com

**Titus Tool Company Ltd.**  
 10 Blackburn Industrial Estate  
 Enterprise Way  
 Sherburn in Elmet  
 LS256NA  
 United Kingdom  
 +44 1977682 582  
 +44 1977680 481 Fax  
 uk@titusplus.com

**CRO-Lama**  
 Rakitska 10a  
 Rakitje  
 HR-10437 Bestovje  
 Croatia  
 +385 1 3323 033  
 +385 1 3323 233 Fax  
 croatia@titusplus.com

**Titus Polska Sp. z o.o.**  
 ul. Stefańskiego 17 A  
 PL-62-002 Suchy Las/Poznań  
 Poland  
 +4861 811 5402 Phone/Fax  
 +4861 811 5684 Phone/Fax  
 +4861 821 9362  
 poland@titusplus.com

**TitusPlus Italia Srl**  
 Via Aquileia 9  
 Frazione Olmi  
 31048 San Biagio di Callalta (TV)  
 +39 04 221 650 120  
 +39 04 221 650 136 Fax  
 italia@titusplus.com

**TitusPlus Iberia SLU**  
 C/ Gran Bretanya 34  
 08520 Les Franqueses del Valles  
 (Barcelona)  
 +34 938 715 404  
 +34 938 605 498 Fax  
 iberia@titusplus.com  
 www.titusplusiberia.com

### America

**Titus Tool Co. Inc.**  
 2800 156th Avenue SE  
 Suite 135  
 Bellevue, WA 98007  
 USA  
 800 762 1616 toll free  
 +1 425 746 2080  
 +1 425 746 2344 Fax  
 usa@titusplus.com

**Titus Tool Co. Inc.**  
 220 Messner Drive  
 US-60090 Wheeling, USA  
 800 762 1616 toll free  
 +1 253 872 2829  
 +1 253 872 2827 Fax  
 usa@titusplus.com

### Australia

**Titus Tekform Pty Ltd**  
 Unit 1, 41-43 Whyalla Place  
 Prestons NSW 2170  
 Australia  
 +61 2 9286 0007  
 +61 2 9826 0074 Fax  
 www.titustekform.com.au  
 info@titustekform.com.au

**Stefano Orlati Ltd**  
 34 Waipareira Avenue  
 Henderson  
 Auckland, New Zealand  
 +64 9 837 0886  
 +64 9 837 8003Fax

### Asia

**Titus Tool Co. Pte. Ltd.**  
 5004 Ang Mo Kio Ave 5  
 Techplace II #04-01  
 Singapore 569872  
 +656383 3922  
 +656383 3178 Fax  
 singapore@titusplus.com

**Titus SZ Components limited**  
 1st Floor, Building No.2,  
 Hengchangrong Hi-tech Industrial Park  
 128 Shangnan East Road  
 Hongtian, Shajing, Baoan District  
 Shenzhen, Guangdong Province  
 PRC 518125  
 +86 755 8348 0916  
 +86 8359 2676 Fax  
 china@titusplus.com

**Titus Tekform Indonesia, PT**  
 Taman Tekno Blok L2 / 7  
 BSD Sektor XI - Tangerang 15314  
 Indonesia  
 T. +62 21 75873578  
 F. +62 21 75873574  
 Indonesia@titusplus.com

### Headquarters

Titus International Ltd  
 325 Euston Road  
 London  
 NW1 3AD, United Kingdom  
 info@titusplus.com

www.titusplus.com  
 info@titusplus.com

# Index

Item number	Page
655-8020	22
655-8021	22
655-8022	22
655-8023	22
655-8024	22
655-8025	30
655-8026	30
655-8027	30
655-8028	30
655-8029	30
655-8060	22, 26, 32
655-8061	22, 26, 32
655-8062	22, 26, 32
655-8063	22, 26, 32
655-8064	22, 26, 32
655-8065	22
655-8066	26
655-8067	26
655-8068	26
655-8069	26
655-8070	26
655-8071	28
655-8072	28
655-8073	28
655-8074	28
655-8075	28
655-8076	30
655-8077	30
655-8078	30
655-8079	30
655-8080	30
655-8081	24, 28, 30, 34, 36
655-8082	24, 28, 30, 34, 36
655-8083	24, 28, 30, 34, 36
655-8084	24, 28, 30, 34, 36
655-8085	24, 28, 30, 34, 36
655-8086	26, 30
655-8087	26, 30
655-8088	26, 30
655-8089	26, 30
655-8090	26, 30
655-8091	28
655-8092	28
655-8093	28
655-8094	28
655-8095	28
655-8096	30
655-8097	30
655-8098	30
655-8099	30
655-8100	30
655-8101	26
655-8102	28
655-8103	30
655-8110	32
655-8111	32
655-8112	32
655-8113	32
655-8114	32
655-8115	34
655-8116	34
655-8117	34

Item number	Page
655-8118	34
655-8119	34
655-8120	36
655-8121	36
655-8122	36
655-8123	36
655-8124	36
655-8160	34
655-8161	34
655-8162	34
655-8163	34
655-8164	34
655-8165	36
655-8166	36
655-8167	36
655-8168	36
655-8169	36
655-8170	32
655-8171	34
655-8172	36
655-8177	22
655-8178	22
655-8179	22
655-8180	22
655-8181	22
655-8182	22
655-8183	22
655-8184	22
655-8185	22, 26, 32
655-8186	22, 26, 32
655-8187	22, 26, 32
655-8188	22, 26, 32
655-8189	22, 26, 32
655-8190	26
655-8191	26
655-8192	26
655-8193	26
655-8194	26
655-8195	28
655-8196	28
655-8197	28
655-8198	28
655-8199	28
655-8200	30
655-8201	30
655-8202	30
655-8203	30
655-8204	30
655-8205	24, 28, 30, 34, 36
655-8206	24, 28, 30, 34, 36
655-8207	24, 28, 30, 34, 36
655-8208	24, 28, 30, 34, 36
655-8209	24, 28, 30, 34, 36
655-8210	26, 32
655-8211	26, 32
655-8212	26, 32
655-8213	26, 32
655-8214	26, 32
655-8215	28
655-8216	28
655-8217	28
655-8218	28

Item number	Page
655-8219	28
655-8220	30
655-8221	30
655-8222	30
655-8223	30
655-8224	30
655-8260	32
655-8261	32
655-8262	32
655-8263	32
655-8264	32
655-8265	34
655-8266	34
655-8267	34
655-8268	34
655-8269	34
655-8270	36
655-8271	36
655-8272	36
655-8273	36
655-8274	36
655-8275	34
655-8276	34
655-8277	34
655-8278	34
655-8279	34
655-8280	36
655-8281	36
655-8282	36
655-8283	36
655-8284	36
655-8285	24
655-8286	24
655-8287	24
655-8288	24
655-8289	24
655-8290	24
655-8291	24
655-8292	24
655-8293	24
655-8294	24
655-8295	24
655-8296	24
655-8297	24
655-8298	24
655-8299	24
655-8300	24
655-8301	24
655-8302	24
655-8303	24
655-8304	24
655-8305	24
655-8306	24
655-8307	24
655-8308	24
655-8309	26
655-8310	26
655-8311	26
655-8312	30
655-8313	30
655-8314	30
655-8315	32
655-8316	32
655-8317	32
655-8318	34
655-8319	34
655-8320	34

Item number	Page
655-8321	36
655-8322	36
655-8323	36
655-8E27	14
655-8E30	14
655-8E35	14
655-8E40	14
655-8E45	14
655-8E50	14
655-8E55	14
655-8F27	16
655-8F30	16
655-8F35	16
655-8F40	16
655-8F45	16
655-8F50	16
655-8F55	16
655-8G27	18
655-8G30	18
655-8G35	18
655-8G40	18
655-8G45	18
655-8G50	18
655-8G55	18
655-8H27	20
655-8H30	20
655-8H35	20
655-8H40	20
655-8H45	20
655-8H50	20
655-8H55	20
655-8T27	14
655-8T30	14
655-8T35	14
655-8T40	14
655-8T45	14
655-8T50	14
655-8T55	14
655-8U27	16
655-8U30	16
655-8U35	16
655-8U40	16
655-8U45	16
655-8U50	16
655-8U55	16
655-8V27	18
655-8V30	18
655-8V35	18
655-8V40	18
655-8V45	18
655-8V50	18
655-8V55	18
655-8Z27	20
655-8Z30	20
655-8Z35	20
655-8Z40	20
655-8Z45	20
655-8Z50	20
655-8Z55	20









Your authorized dealer

Titus Group  
[www.titusplus.com](http://www.titusplus.com)

TekformDrawerSlimline 02.2 ENG Aug18